

M. Pechenik,
orcid.org/0000-0002-4527-1125,
S. Burian,
orcid.org/0000-0002-4947-0201,
M. Pushkar,
orcid.org/0000-0002-9576-6433,
H. Zemlianukhina,
orcid.org/0000-0002-9653-8416

National Technical University of Ukraine “Igor Sikorsky Kyiv Polytechnic Institute”, Kyiv, Ukraine, e-mail: annzemlya@gmail.com

ELECTROMECHANICAL SYSTEM OF TURBOMECHANISM WHEN USING AN ALTERNATIVE SOURCE OF ELECTRIC ENERGY

Purpose. Development of a water supply unit in the conditions of pressure control fed from a renewable source of electric energy with static compensator (STATCOM).

Methodology. The research was carried out by the method of mathematical modeling in the application packages MATLAB SimPowerSystems and Simulink. The object of the study is a turbomechanism control system, which is powered by a wind turbine when regulating the voltage and realizes the pressure stabilization during the daily cycle of hydraulic resistance variations. The subject of the study is the structure development of a given level of pressure stabilization in the water supply unit.

Findings. A mathematical model of a water supply control system powered by a wind turbine is presented. The unit tests the pressure at a given level in accordance with technological requirements. The nature of the variation in pump performance within the daily cycle of consumption when powered by a wind turbine, which in turn performs regulation using a static compensator, is studied.

Originality. The system regulates the generated voltage by using a STATCOM, which allows you to maintain its level constant regardless of changes in the network hydraulic resistance.

Practical value. Today, the use of alternative energy sources is becoming increasingly important. The developed conception will allow improving the existing water supply systems and designing new ones. It allows you to adjust the set level of pressure stabilization, while the output of generator is maintained constant under constant wind conditions.

Keywords: *turbomechanism, pressure stabilization, asynchronous generator, voltage regulation, hydraulic resistance of the network, automatic control*

Introduction. The increasing cost of energy used in the production of electricity, makes the transition to renewable energy sources relevant in the world, as it allows obtaining electricity economically and environmentally friendly. And in some areas where laying the electric network is unprofitable and impractical, it is possible to implement only autonomous power generation units. Typically, such structures are based on a combination of a drive motor – a wind or hydro turbine, or an internal combustion engine, and an electric generator. Such structures require low cost, high resource and reliability, long service intervals and low qualification requirements for service personnel. Sometimes people's lives and the ability to connect with the outside world depend on the autonomous power generation unit operation.

At the same time, the task of stabilizing hydronetwork pressure with a high degree of accuracy is quite relevant, which reduces the performance of the elements of both the pump and the hydrosystem, and the lack of which usually leads to failure of the technological process and living conditions, contributes to emergencies, reducing the level of operational reliability of the hydraulic scheme elements.

Literature review. Now renewable energy sources are used for pumping liquids. Mechanically coupled wind turbines with liquid supply systems are the most common method for pumping water into agricultural arable land and meeting the livestock needs on farms [1]. Herewith, the pump is connected to the turbine via a motor-generator connection [2]. Whereas the connection is electrical, the generator can be located in the optimal area where the maximum air flow energy can be obtained while the pump stands near the river or the pond or a tank [3].

Both structures with synchronous and asynchronous generators are used to control water supply systems powered by alternative energy sources. Among the water supply systems with variable speed turbines, there are two main configurations. One of them is a direct connection between the generator and the motor stator. In this case, the speed of both machines is kept constant. The main disadvantage is that the components must

be selected with the parameters that are satisfactory on a case by case basis. This is due to the fact that for increasing the scheme efficiency, it is necessary that the characteristic load curves generated by the pump at different velocities coincide with the wind turbine optimal torque curve. The second configuration is made of two converters that allow the turbomechanism and the turbine to be disconnected. In this case, there is no need for precise alignment of the pump and turbine parameters, but the inverters must have sufficient capacity to control the pump at rated power, which significantly increases the cost [4].

Turbines based on autonomous self-excitation induction generators (SEIG) have recently become increasingly common among alternative electricity generation from renewable sources [5]. The main problem of implementing these SEIG in power networks is the problem of voltage control at the output of SEIG; this problem can be solved using several different approaches. Usually when developing the serial induction generators (IGs), a lot of attention is paid to how to make the system cheaper and easier to maintain, yet reliable and with high quality of the generated energy [6].

Among the current market trends of such structure, the most widespread are generators with output regulation using an electronic load controller (ELC) [7] and static compensator (STATCOM) [8]. Such schemes allow the amplitude and frequency of the generated voltage to be smoothly adjusted, and ensure its consistency in a wide range of changes in the IG rotation speed and changes in its load [9]. Stabilization of this parameter also avoids the collapse in case of high overload on it [10].

Another option for solving the problem of controlling such units is proposed by the authors in [11]. The centrifugal turbomechanism, which is mechanically switched to the induction motor, is controlled by a wind turbine with an asynchronous doubly-fed generator. Doubly-fed electric machine auxiliary power supply is carried out through the generator stator, changing the frequency and voltage of its excitation by two frequency converters DC/AC and AC/DC. The presence of two converters in the unit is one of the attractive features, as it is possible to include an additional energy source from other types of alter-

natives, such as solar energy, the use of biogas [12], which do not require additional regulation. The DC bus connects the main and auxiliary machines via two converters so that the turbo-mechanism can be powered from both sources.

The authors of the article [13] proposed a control structure for a pump with a dual-supply machine, where the auxiliary control is carried out through the doubly-fed machine stator using an AC/AC frequency converter. This solution allows separating the prime mover from the pump, which significantly reduces the flow of electricity through the converter. The proposed configuration reduces the required converter nominal parameters, while reducing the cost, improving its performance. The strategy of torque control by varying the auxiliary stator frequency allows working at a variable velocity. For the best performance at the nominal values of both motors, the frequency control law U/f in the AC circuit was used.

Particular attention should be paid to stability and reliability of water supply structures for both industrial and residential complexes, which allows one to ensure the technological process requirements, comfortable conditions in residential buildings, and others. The most common solution to this problem is to ensure the pressure stabilization in the hydraulic network by adjusting the performance depending on the hydraulic resistance change.

Therefore, the task of developing a water supply unit powered by a wind turbine with voltage regulation is quite relevant in the implementation of pressure stabilization to meet the requirements of both technological processes and housing and communal needs [14].

The growing interest in the implementation of renewable energy and the rapid development of power electronics allow manufacturers to find the most acceptable and inexpensive technologies for their implementation.

Purpose. The aim of the work is to develop an electromechanical water supply system powered by an induction generator with controlled voltage, provided the pressure stabilization of the hydraulic network.

Methods. The investigations were performed on the basis of a control system powered by SEIG, while stabilizing the hydraulic network pressure, whose functional diagram is shown in Fig. 1.

Fig. 1 introduces the following notations: *IG* – induction generator; *STATCOM* – static compensator; *FC* – frequency converter; *IM* – induction motor; *P* – pump unit; u_1^*, u_2^* – tasks for voltage and pressure, respectively; *VC* – voltage controller set to PI law; *PC* – pressure controller set to PI law; K_{fU}, K_{fH} – voltage and pressure feedback coefficients, respectively; ω_1 – IG rotor angular speed; ω – pump velocity; T_L – load torque on the shaft; *Q* – productivity; *H* – pressure; ω^* – given speed; U_a, U_b, U_c – stator phase voltage; U_{abc} – given stator phase voltage.

The main elements of the developed electromechanical system are to be described. The scheme is made with two frequency converters, which will allow placing the wind turbine and pump separately from each other to increase the efficiency in selecting the optimal areas for objects.

The IG rotor rotates by means of a wind turbine with a constant velocity regardless of the air flow variation. The parallel battery of capacitors, which is connected in a triangle, provides SEIG self-excitation. The capacitor battery in struc-

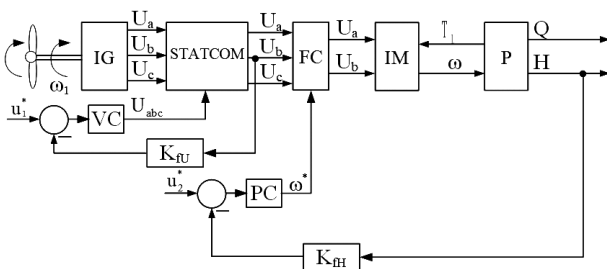

Fig. 1. Functional diagram of the investigated structure

tures with a static compensator is calculated so that the process of SEIG self-excitation successfully can take place when the rated load is connected to the generator. A more accurate calculation of the capacitor bank capacitance is facilitated by a preliminary calculation of boundaries of IG self-excitation in coordinates “capacity-speed-load”, and analytical obtaining of static characteristics of the generated voltage [15].

The static compensator inverter (STATCOM) is controlled from the signals coming from the PWM controller, which gives a signal to close the inverter keys depending on the amount of voltage received from the controller. The regulator maintains a constant SEIG output, which in turn makes the generated voltage constant rate.

A well-known mathematical model of an SEIG in an orthogonal coordinate frame rotating at an arbitrary speed is described by the following nonlinear differential equations [16].

$$\begin{aligned} \frac{d\Psi_1}{dt} &= U_1 - R_1 i_1 - \omega_e J \Psi_1; \\ \frac{d\Psi_2}{dt} &= -R_2 i_2 + (p_n \omega_1 - \omega_e) J \Psi_2, \end{aligned} \quad (1)$$

where $J = \begin{bmatrix} 0 & -1 \\ 1 & 0 \end{bmatrix}$, $\Psi_1 = [\Psi_{1d} \ \Psi_{1q}]^T$, $\Psi_2 = [\Psi_{2d} \ \Psi_{2q}]^T$ are stator and rotor flux linkage vectors, respectively; $i_1 = [i_{1d} \ i_{1q}]^T$, $i_2 = [i_{2d} \ i_{2q}]^T$ are vectors of stator and rotor currents, respectively; $U_1 = [U_{1d} \ U_{1q}]^T$ is a stator voltage vector; R_1 and R_2 are active stator and rotor resistance; p_n – number of pole pairs; ω_e is the angular rotation speed of an arbitrary d - q coordinate frame.

The capacitor self-excitation battery with a capacity of C is connected in parallel to the IG stator windings, a three-phase load in the form of a three-phase centrifugal pump with adjustable speed are also connected to it. The workload created by the pump is due to the change in resistance in the hydro network, which it supplies with water, in accordance with the daily cycle of water consumption by housing and communal services.

The equation for the stator voltage, which is also the same on the battery capacitors for self-excitation, can be obtained on the basis of Kirchhoff's second law as follows

$$\begin{aligned} -C \frac{dU_1}{dt} &= i_1 + i_L + \omega_e C J U_1; \\ Y_L L_L \frac{di_L}{dt} &= Y_L U_1 - i_L - \omega_e Y_L L_L J i_L, \end{aligned} \quad (2)$$

where $i_L = [i_{Ld} \ i_{Lq}]^T$ is a consumer current vector; Y_L is consumer active component conductivity; L_L is consumer inductance; C is self-excitation battery capacity. The amounts of workloads and capacities in each phase are the same.

The following equations determine the stator and rotor flux linkage

$$\begin{aligned} \Psi_1 &= L_{\sigma 1} i_1 + L_M (i_1 + i_2); \\ \Psi_2 &= L_{\sigma 2} i_2 + L_M (i_1 + i_2), \end{aligned} \quad (3)$$

where $L_{\sigma 1}$ and $L_{\sigma 2}$ are stator and rotor windings scattering inductance; L_M is mutual inductance of the stator and rotor (magnetization inductance), which, due to the magnetic saturation, is nonlinearly dependent on the magnetizing current

$$L_M = f(i_M); \quad i_M = \sqrt{i_{Md}^2 + i_{Mq}^2}; \quad i_{Md} = i_{1d} + i_{2d}; \quad i_{Mq} = i_{1q} + i_{2q}.$$

The analysis of SEIG operation as a part of autonomous systems of electric energy generation needs analytical definition of working zones in which self-excitation is possible – so-called self-excitation boundaries. In the investigation course, analytical expressions were used to calculate the exact value of the capacitor bank capacitance, by means of which the limit of self-excitation is obtained as the speed on the capacitance dependence, with constant other system parameters.

For the case of connecting a capacitor bank parallel to the stator winding and active-inductive load, analytical dependences have the form

$$\begin{aligned} \omega = \omega_e^* / n_p - [R_2(1 + Y_L R_1) - \\ - \omega_e^{*2} C R_2 (L_1^* + Y_L R_2 L_L) / n_p \omega_e^* (Y_L (L_1^* L_2^* - L_M^{*2}) + R_1 L_2^* C - \\ - Y_L L_L \omega_e^{*2} C (L_1^* L_2^* - L_M^{*2}) + Y_L L_L L_2^*)] \end{aligned} \quad (4)$$

Based on (4), varying the capacitance C , two curves are calculated, which are interconnected at points when the upper and lower capacitance limits are reached, creating a closed region – this is the self-excitation zone, in which the SEIG is stable and generates voltage. Repeating this procedure for different conductivities and load inductances, a family of curves for self-excitation boundaries in the $C-\omega$ coordinates can be obtained, which allows predicting the possibility of self-excitation when changing operating conditions.

Transients in a single pump unit taking into account the hydraulic network are described by a system of equations [17] and are presented in the block diagram, which is shown in Fig. 2.

In Fig. 2 the following notations are entered: H_{0n} – nominal pressure at zero feed at nominal speed; ω_n – pump nominal speed; H_{st} – geodetic height of water level; χ – integration time constant; a_n – nominal hydraulic resistance.

The work of consumers in this model is approximated by a given hydroresistance in accordance with the schedule of water consumption, which is selected depending on the operating conditions and the electromechanical system scope.

The consumer torque on the drive induction motor is formed as follows

$$T_L = KQH/\omega, \quad (5)$$

where $K = \rho g/\eta$ is the coefficient in which ρ is liquid density; g is free fall acceleration; η is unit efficiency.

The synthesis of the pressure controller (PC) (Fig. 1) is performed on the basis of equations based on the structural diagram (Fig. 2) and (5). First, using the method of finite increments, the expression written with respect to H in the linearized around the operating point is obtained. Since the character of parameters' changes is nonlinear, it is necessary to write the equation in the following increments: $\omega = \omega + \Delta\omega$; $H_{st} = H_{st} + \Delta H_{st}$; $Q = Q + \Delta Q$; $H = H + \Delta H$. The obtained equations, as a result of taking into account the increments, can be simplified by neglecting small amounts of the second and third order and given that $\omega = \omega_n$.

As a result of a number of mathematical transformations, introduction of the operator $p \rightarrow d/dt$ and control circuit adjustment to the modular optimum, a mathematical description of the PC, which provides pressure stabilization in the hydro-system, is obtained [18, 19].

$$W_{PC}(p) = K_H + \frac{1}{(T_m + T_H)p + 1}, \quad (6)$$

where $W_{PC}(p)$ is PC transfer function; $K_H = \omega_n p_n (a_n + a) / 8\pi T_\mu K_{FH} H_{0n} a$; $T_H = \chi / 2(a_n + a)Q$ are entered variables; T_μ

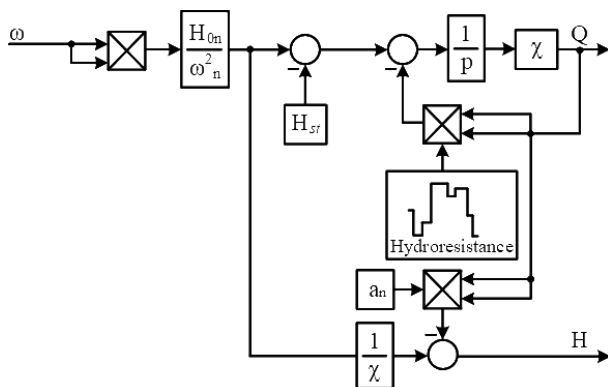

Fig. 2. Block diagram of the investigated pump unit

is uncompensated time constant; T_m is mechanical time constant; a is water supply network hydraulic resistance.

A well-known system of equations is used to describe an induction motor and a frequency converter (FC) that implements the quadratic law of voltage–frequency control $U/f^2 = \text{const}$ [20].

The SEIG output is regulated by a voltage controller (VC) using the transformations $abc-dq$ and $dq-abc$, where dq is the coordinates of the two-phase model of an induction motor, abc is the coordinates of a three-phase model of an induction motor. The VC output is a vector containing three modulating signals used by the PWM to generate 6 IGBT pulses to control the inverter when the load on the generator output, due to the daily cycle of water consumption.

Based on the previously presented electromechanical system mathematical models, models for indicators of the head stabilization level in the hydraulic structure when powered by a wind turbine were obtained within the MATLAB SimPowerSystems and Simulink application packages.

One of the typical schedules of water consumption within the daily cycle of residential buildings water supply was adopted for research [19], the character of the change in the network hydroresistance is shown in Fig. 3.

Taking into account the complexity and time of modeling, the daily cycle of hydraulic resistance change (Fig. 3) during modeling was made on a scale and is (0–30) s, which corresponds to (0–24) hours. This scaling is possible because the processes in the diurnal cycle are stable, so the change in modeling time does not make significant errors in research results. The daily cycle begins with 5 s, because it must first overlock the prime mover and motor.

The daily cycle (Fig. 3) is conventionally divided into four main periods: morning (6–12) hours, afternoon (12–17) hours, evening (17–21) hours and night (21–6) hours. The busiest are morning and evening periods, so the network hydraulic resistance is the lowest.

The investigations were performed for the SEIG with a power of 5,500 W, the induction motor – 4,000 W and the pump – 3,700 W. The head stabilization level is 48 m, which is the nominal pressure for the selected unit.

Simulations were carried out for the following sequence of control operations of the induction generator with self-excitation and the drive motor of the pump unit:

- at the time 0–0.1 s, self-excitation IG was dispersed to the speed of 157 rad/s, at a full nominal consumption of 5,500 W connected to the outputs;
- at the time 0.1–5 s, the IM accelerated to the nominal speed at the nominal load of the hydraulic network;
- at the time 4.5–5 s, the liquid, rising to a given head level, overcomes the load magnitude due to static pressure H_{cm} acting from top to bottom;

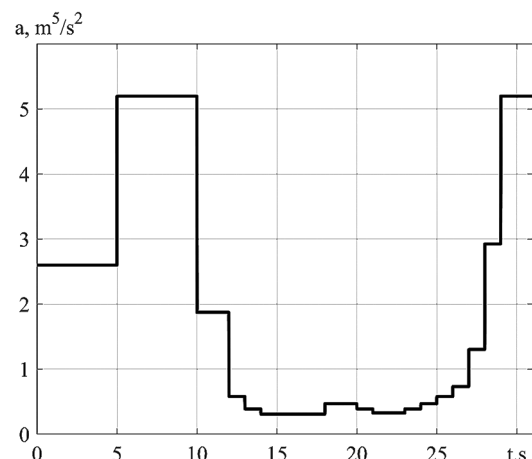

Fig. 3. Graph of the hydraulic resistance variations, $a/10^7$

- at the time 5–30 s, the consumption changed according to the water consumption daily cycle, according to the schedule of resistance change (Fig. 3).

Results. The results of the investigation of the pump unit and the generator are shown in Figs. 4–8.

From the graphs of transients in the pump installation (Fig. 4) it is seen that during the change in hydraulic resistance, the PC works out the set value with a small dynamic error. This

error is not more than 1 %, which is acceptable for technological, housing and communal requirements. The maximum performance is reached in the morning and evening periods, at the same time the pump and the motor work in nominal modes. The presence of the error of working out the set pressure is also due to the stiff hydroresistance change nature.

After accelerating the SEIG to an angular speed of 157 rad/s the self-excitation takes place. At time 4.5 s, the pro-

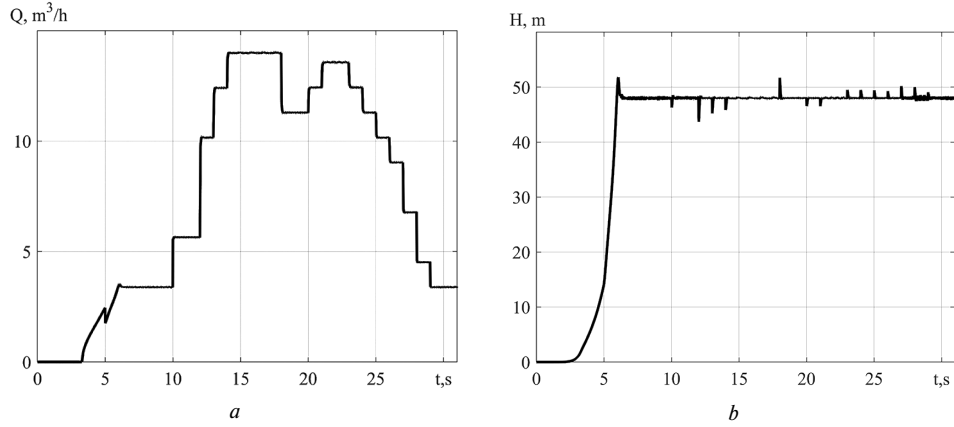

Fig. 4. Transients in the pump:
a – productivity, Q ; b – pressure, H

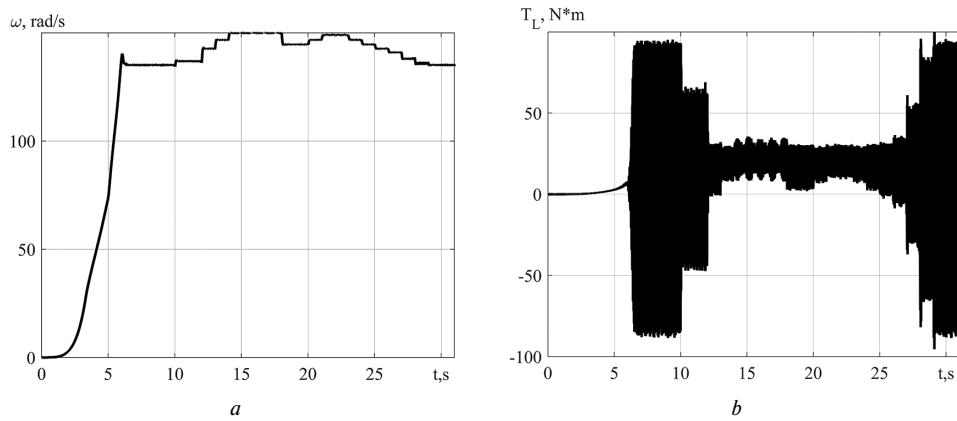

Fig. 5. Transients in the pump:
a – motor angular speed, ω ; b – drive motor torque, T_L

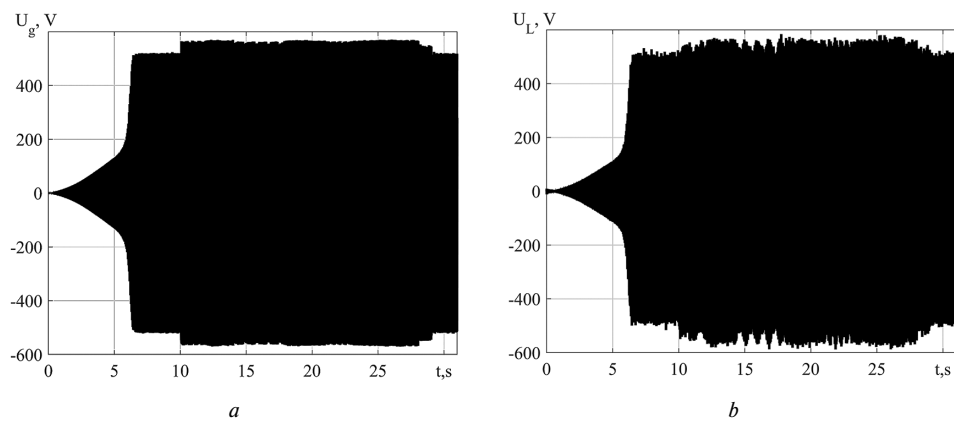

Fig. 6. Transients in the IG:
a – line-to-line SEIG voltage, U_g ; b – line-to-line load voltage, U_L

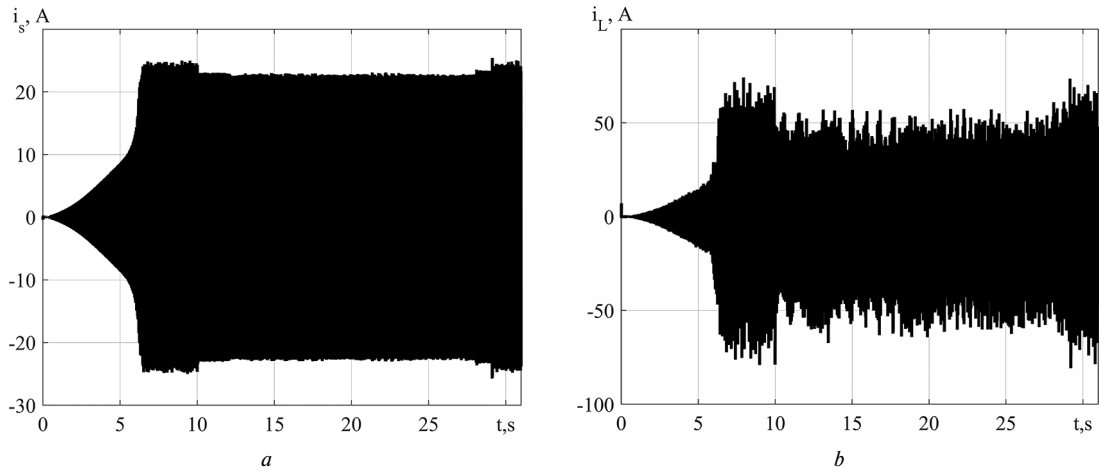

Fig. 7. Transients in the IG:
a – stator line current, i_s ; b – line current, i_L

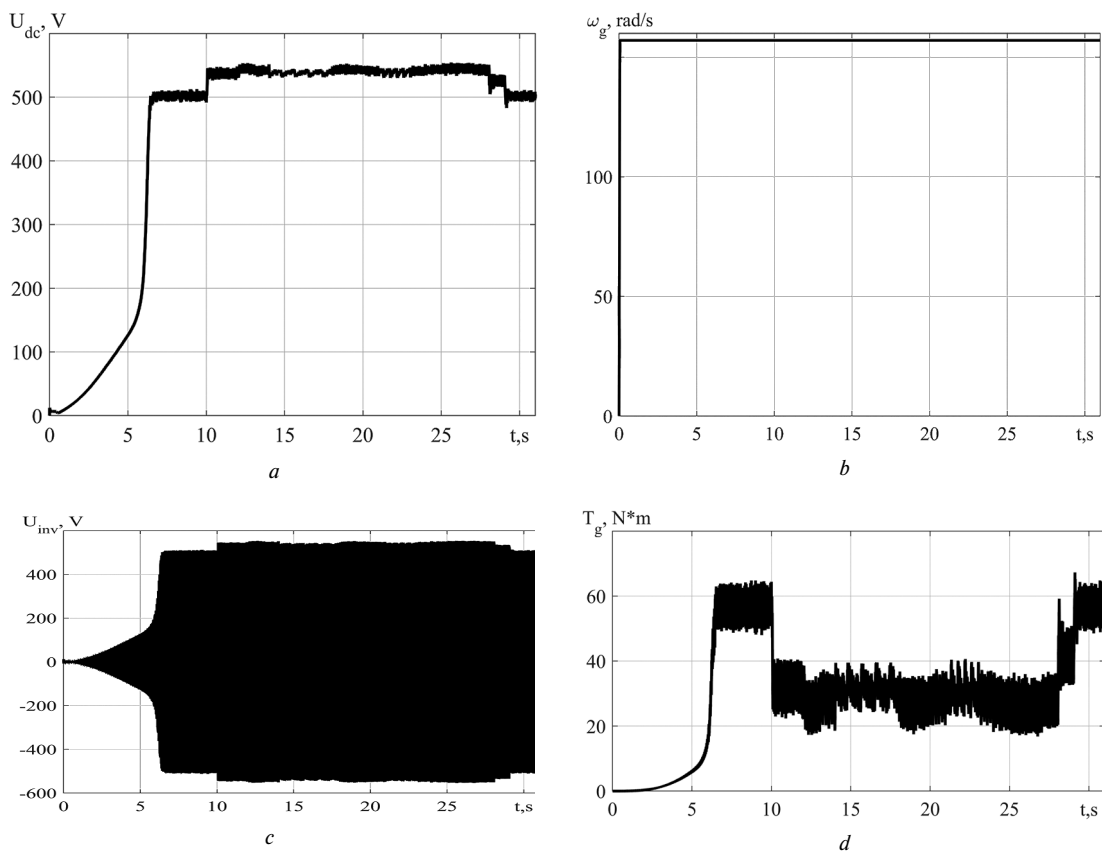

Fig. 8. Transients in the IG:
a – DC-link voltage, U_{dc} ; b – rotor speed, ω_g ; c – line-to-line inverter voltage, U_{inv} ; d – torque, T_g

cess of self-excitation has taken place and the generated voltage reached the rated value. The turbine is switched on immediately with a pump unit. The average of the IG electromagnetic moment is about 58 Nm and the voltage in the DC link is 505 V. Its value between the lines is 450 V. At a load of 5,500 W, the value of the line current is 35 A.

After changing the consumption according to the schedule of hydraulic network load distribution for one daily cycle at a time of 10 s, the linear current has a rate of 20 A, and the SEIG output from line to line increases from 505 to 550 V. Forms of current and voltage are somewhat distorted due to the nonlinearity of the consumer. Increasing the IG voltage leads to an increase in the voltage in the DC circuit to 540 V.

With the help of a VC, the output line load voltage is stabilized at 510 V. This confirms the fact that the proposed concept implementation makes it possible to maintain the output value at a constant nominal level regardless of hydroresistance.

Fluctuations of the linear current are caused by switching of IGBT switches in inverters of frequency converters.

Conclusions. Investigations show that the developed structure allows stabilizing the pressure of hydraulic networks at a given level when changing its resistance in accordance with technological requirements. In this case, the dynamic error of the head does not exceed 1 %.

The developed model in MATLAB allows analyzing the system of level and frequency regulation of generator output feeding

the turbomechanism, by means of the frequency converter in various modes and daily loadings of a water supply network.

Given the analysis of the research, it is recommended to use the results obtained both in the design of new and in the reconstruction of existing units for transportation of liquid substances using autonomous energy sources based on self-excited induction machine.

References.

1. Camocardi, P., Battaiotto, P., & Mantz, R. (2010, March). Autonomous water pumping system based on wind generation. Control by rotor frequency. *2010 IEEE International Conference on Industrial Technology*, 903-908. <https://doi.org/10.1109/ICIT.2010.5472568>.
2. Mousavi, Z., Fadaeinedjad, R., Moradi, H., Bagherzadeh, M., & Moschopoulos, G. (2020, October). A New Configuration for Wind/Solar Water Pumping System Based on a Doubly Fed Induction Generator. *2020 IEEE Energy Conversion Congress and Exposition*, 1891-1898. <https://doi.org/10.1109/ECCE44975.2020.9235941>.
3. Beshta, O., Yermolayev, M., Kaiser, K., Beshta, P., & Taylor, A. (2013). Limitations of the indirect field oriented control utilization for electric drives of pipeline valves. *Energy efficiency improvement of geotechnical systems – Proceedings of the International Forum on Energy Efficiency*, 19-28. <https://doi.org/10.1201/B16355>.
4. Malyar, A. V., Mysyurenko, V. A., Gyke, R. V., & Dzhal, Ya. E. (2013). Automated control system of technological process of water supply. *Energoberezhennia. Energetika. Energoaudit*, 12(118).
5. Beshta, A., Aziukovskyi, O., Balakhontsev, A., & Shestakov, A. (2017, November). Combined power electronic converter for simultaneous operation of several renewable energy sources. *2017 International Conference On Modern Electrical And Energy Systems*, 236-239. IEEE. <https://doi.org/10.1109/MEES.2017.8248898>.
6. Chilipi, R. R., Singh, B., Murthy, S. S., Madishetti, S., & Bhuvanawari, G. (2014). Design and implementation of dynamic electronic load controller for three-phase self-excited induction generator in remote small-hydro power generation. *IET Renewable Power Generation*, 8(3), 269-280. <https://doi.org/10.1049/IET-RPG.2013.0087>.
7. Kiselychynk, O., Bodson, M., & Wang, J. (2013, June). Model of a self-excited induction generator for the design of capacitor-controlled voltage regulators. *21st Mediterranean Conference on Control and Automation*, 149-154. IEEE. <https://doi.org/10.1109/MED.2013.6608713>.
8. Youssef, K. H., Wahba, M. A., Yousef, H. A., & Sebakhly, O. A. (2010). A new method for voltage and frequency control of stand-alone self-excited induction generator using pulse width modulation converter with variable DC-link voltage. *Electric Power Components and Systems*, 38(5), 491-513. <https://doi.org/10.1080/15325000903376008>.
9. Nazarova, O., Osadchyy, V., & Brylysty, V. (2020, September). Research on the Influence of the Position of the Electric Vehicles Mass Center on Their Characteristics. *2020 IEEE Problems of Automated Electrodrive. Theory and Practice*, 1-4. <https://doi.org/10.1109/PAEP49887.2020.9240824>.
10. Ganesh, A., Dahiya, R., & Singh, G. K. (2016, December). Development of simple technique for STATCOM for voltage regulation and power quality improvement. *2016 IEEE International Conference on Power Electronics, Drives and Energy Systems*, 1-6. <https://doi.org/10.1109/PEDES.2016.7914421>.
11. Camocardi, P., Battaiotto, P., & Mantz, R. (2010). Autonomous BDFIG-wind generator with torque and pitch control for maximum efficiency in a water pumping system. *International Journal of Hydrogen Energy*, 35(11), 5778-5785. <https://doi.org/10.1016/j.ijhydene.2010.02.099>.
12. Fedoreyko, V. (2015). Independent power supply of menage objects based on biosolid oxide fuel systems. In Beshta, O., Fedoreyko, V., Palchyk, A. & Burega, N. (2015). *Power engineering, control & information technologies*, (pp. 33-39). Boca Raton, London, New York, Leiden: CRC Press.
13. Rodrigo, J. B., Munté, X., Valderrama-Blavi, H., & González-Molina, F. (2013, March). Design and testing of a dual stator winding induction generator. *10th International Multi-Conferences on Systems, Signals & Devices 2013*, 1-6. <https://doi.org/10.1109/SSD.2013.6564062>.
14. Pechenik, M., Burian, S., Zemlianukhina, H., & Pushkar, M. (2020, May). Investigation of the Hydraulic Pressure Stabilization Accuracy in the Conditions of Water Supply Cascade Pump System Operation. *2020 IEEE 7th International Conference on Energy Smart Systems*, 97-100. <https://doi.org/10.1109/ESS50319.2020.9160340>.
15. Pechenik, M. V., Bovkunovich, V. S., & Pushkar, M. V. (2015). Voltage regulation of the induction generator with self-excitation by means of the electronic load regulator. *Elektromehanichni i enerhoz-*

berihaiuchi systemy, (3), 82-88. Retrieved from https://nbuv.gov.ua/UJRN/emezs_2015_3_12.

16. Bodson, M., & Kiselychynk, O. (2012). Analysis of triggered self-excitation in induction generators and experimental validation. *IEEE Transactions on Energy Conversion*, 27(2), 238-249. <https://doi.org/10.1109/TEC.2012.2182999>.
17. Gevorkov, L., Vodovozov, V., & Raud, Z. (2016). Simulation study of the pressure control system for a centrifugal pump. *2016 57th International Scientific Conference on Power and Electrical Engineering of Riga Technical University*, 1-5. <https://doi.org/10.1109/RTUCON.2016.7763086>.
18. Osadchyy, V., & Nazarova, O. (2020, September). Laboratory Stand for Investigation of Liquid Level Microprocessor Control Systems. In *2020 IEEE Problems of Automated Electrodrive. Theory and Practice*, (pp. 1-4). <https://doi.org/10.1109/PAEP49887.2020.9240868>.
19. Pechenik, M., Burian, S., Pushkar, M., & Zemlianukhina, H. (2019, September). Analysis of the Energy Efficiency of Pressure Stabilization Cascade Pump System. *2019 IEEE International Conference on Modern Electrical and Energy Systems*, 490-493. <https://doi.org/10.1109/MEES.2019.8896588>.
20. Burian, S. O., Kiselychynk, O. I., Pushkar, M., Reshetnik, V. S., & Zemlianukhina, H. Y. (2020). Energy-Efficient Control of Pump Units Based on Neural-Network Parameter Observer. *Tekhnichna Elektrody-namika, 2020*, 71-77. <https://doi.org/10.15407/TECHNED2020.01.071>.

Електромеханічна система турбомеханізму при використанні альтернативного джерела електричної енергії

М. В. Печеник, С. О. Бур'ян, М. В. Пушкар,
Г. Ю. Землянхуна

Національний технічний університет України «Київський політехнічний інститут імені Ігоря Сікорського», м. Київ, Україна, e-mail: annzemlya@gmail.com

Мета. Розробка системи водопостачання, в умовах стабілізації напору, що живиться від відновлювального джерела енергії при використанні статичного компенсатора (STATCOM).

Методика. Дослідження проводилися за допомогою математичного моделювання в пакетах прикладних програм MATLAB SimPowerSystems і Simulink. Об'єктом дослідження є система автоматичного керування (САК) турбомеханізмом, що живиться від вітрогенератора в умовах регулювання напруги й реалізує стабілізацію вихідних параметрів насосної установки за добового циклу споживання води мережі. Предметом дослідження є відпрацювання САК заданого рівня стабілізації тиску в системі водопостачання.

Результати. Приведена математична модель САК насосної установки, що живиться від вітрогенератора. САК відпрацьовує тиск на заданому рівні відповідно до технологічних вимог. Досліджено характер варіації продуктивності насосу в межах добового циклу споживання води при живленні від вітрового генератора, що, у свою чергу, виконує регулювання тиску за допомогою статичного компенсатора.

Наукова новизна. У системі реалізується регулювання генерованої напруги за допомогою використання STATCOM, що дозволяє підтримувати рівень напруги постійним незалежно від зміни гідравлічного опору мережі.

Практична значимість. На сьогоднішній день використання альтернативних джерел енергії набуває широкого значення. Розроблена концепція дозволить удосконалити існуючі системи водопостачання та проектувати нові. Вона дозволяє регулювати заданий рівень стабілізації тиску, при цьому генерована напруга буде підтримуватися постійною за умови незмінного вітру.

Ключові слова: турбомеханізм, стабілізація напору, асинхронний генератор, регулювання напруги, гідроопір мережі, автоматичне керування

The manuscript was submitted 09.07.21.