

THE AIR CHANNEL FUNCTION IN REAL LIFE – INSULATION AGAINST RISING DAMP IN HISTORICAL BUILDINGS

© Ladislav Tazky, Anna Sedlakova, 2016

Метою дослідження є знайти адекватне рішення щодо підвищення відносної вологості в історичних будівлях. Для вирішення цієї проблеми запропоновано використати вентилявані повітряні канали. Дослідження проводили для особливої групи історичних будівель церков, тому що в них не використовують процедури зволоження повітря у приміщеннях, як, наприклад, у музеях та галереях. Було розроблено чотири конструкції вентиляваних повітряних каналів: відкритий, закритий, з надлишковим тиском, з розрідженням. Перевіряли конструкцію у програмному забезпеченні Ansys CFX повітряного потоку каналів для однакових відрізків каналів. Проведені дослідження показали, що кращою конструкцією є вентилявані повітряні канали з розрідженням. Така конструкція каналів дає змогу досягти найвищих значень швидкості руху повітря. Недоліком такої конструкції є неестетичний вигляд конструкції, оскільки труби встановлено на фасаді, всередині дренажної труби. Це дослідження дає змогу архітекторам вирішити проблему підвищення відносної вологості в історичних будівлях. Для прийняття правильного рішення необхідно досліджувати кожну конкретну споруду. Метою дослідження є підготовка процесу проектування вентиляваних повітряних каналів для архітекторів без моделювання кожної будівлі, перетину або геометрії конструкції.

Ключові слова: історичні будівлі, вентиляваний повітряний канал, підвищення відносної вологості в історичних будівлях.

The purpose of the research is to find adequate solution against rising damp in historical buildings. The improvement in this case is the use of ventilated air channels. A special group of historical buildings are churches because they do not use routines as for example museums, galleries. We designed 4 differently constructed ventilated air channels. These are: open or closed, with overpressure and underpressure. As a verification we use a relevance to these constructions which we simulated in software Ansys CFX the air flow of channels. We modelled the equal segments of the channels. The best solution of these constructions are the ventilated air channels with underpressure system. In this solution we measured the highest values of air velocity. Nevertheless this solution is not an aesthetic form of construction, because the pipes are set on the facade. But these pipe are put inside the drainage pipe. This research should offer the solution for architects against problems of rising damp in historical buildings. To find the right solution is necessary to research every case. The aim of the research is to prepare the design process of the ventilated air channels for the architects without the simulation of every building, cross section or geometry of the construction.

Key words: historical buildings, ventilated air channel, rising damp in historical buildings.

Introduction. Moisture is a major source of damage in historic solid masonry. Rising damp is a well-known phenomenon around the world and occurs when groundwater flows into the base of a construction and is allowed to rise through the pore structure. From practical experience it is known that many factors may play a role regarding permeability problems in masonry. The amount of possible causes

of moisture problems in historic masonry underlines the complexity of this phenomenon. Evaporation is an important factor in rising damp. The surface of an affected wall contains moisture that has risen from the ground and this moisture is then subject to evaporation. The factors controlling evaporation include: temperature, humidity, air movement and surface.



*Fig. 1. Churches in region Gemer (Slovakia):
left – Žíp; center – Šivetice; right – Rybník*

Visual survey. During the visual survey it was found that moisture content of the internal masonry pillars reaches up to the height at around 1700–1900 mm. The situation was the worst at the apse of the east side of the church. On the inner surface of the plaster there was visible efflorescence and mildew occurrences especially in the higher parts of the plinth. On the outside of the walls there are still visible lichens, mosses and algae. During the reconstruction of the 80es a gutter walkway was built around the church which only worsened the situation. The biggest problem is the concrete sidewalk on the west side of the church, which compresses the water towards the walls and concentrate at the foundations.



*Fig. 2. Church in Gemerský Jablonec:
left – church in nowadays; right – church in 1932*

Samples were taken from the perimeter walls for moisture laboratory evaluation. Each sample is taken from the plaster or mortar from the peripheral wall. These samples were collected from the bottom of the wall. The highest value of moisture at around 9 % have been measured on the east side of the outer walls of the apse.



*Fig. 3. Damages on the church Gemerský Jablonec:
1 – damp on the facade; 2 – damp maps on the wall; 3 – nonfunctional drainage system*

In the summer of 2013, work began on the dehumidification of masonry which started by removing of the original plaster to the height at around 1500 mm and replaced by the appropriate remediation plaster.

Design the ventilated air channel. The church is a protected cultural monument and a historic value should be particularly sensitive to any remediation done. To improve the technical condition of the church minor structural modification is required. The drain pipes will be replaced with outdoor air channels. The channel must be masoned of ceramic burned bricks with lime-cement mortar to ensure the natural evaporation of moisture from the soil through the brick masonry. The bottom of the air channel will be filled with gravel; the drain pipe will be placed in this layer to ensure the drainage of water. The next step will be the coverage of the channel with precast concrete panels. These panels are perforated to ensure the natural evaporation from the channel. These numerical applications present the aerodynamic analysis of the building and all versions of the terrain geometry. We designed the 80.0 m wide section in the software Ansys CFX surrounded with air boundary. From the 2D model of the section we transformed a 3D version with the function “extrude”. The sizes of the environments are designed according the principles of the air flow. The present simulation is considered the turbulence fluctuation in the inflow boundary condition.

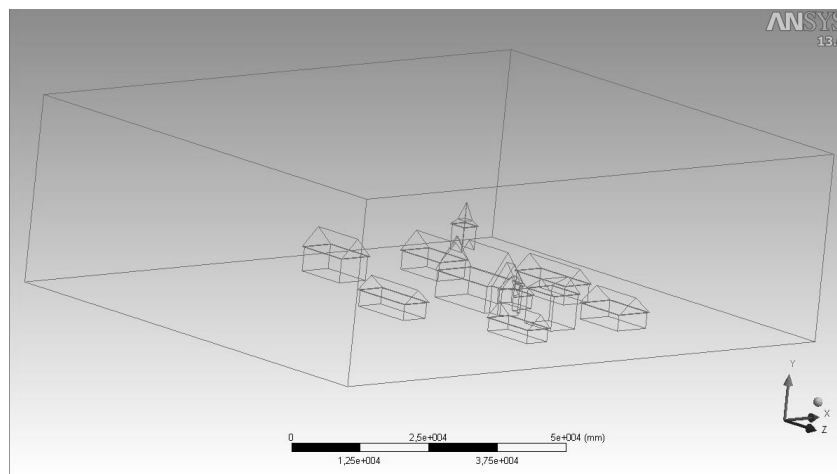

Fig. 4. Geometrical characteristics of the computational domain for the full model

The general domain size for the numerical model was set at $113.2 \times 80.0 \times 35.0 \text{ m}^3$. The distance between the inlet section and the center of the building was 74.1 m. The full height of the building is 10.96 m, respectively the height of the wall was 4.7 m; the width was 8.2 m and the roof angle was 54.64° .

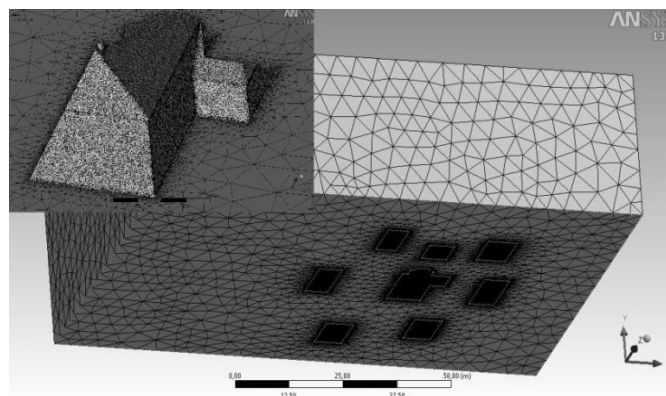

Fig. 5. Mesh characteristics of the computational domain for full model mesh

The overall model is meshing to the maximum size of the elements of 0.3 m. Surface edges are condensed to the element size of 0.25–0.05 m, depending on the versions. Figure 5 shows the mesh of the

full model. This model is constituted by 877,315 elements and 117,042 nodes. Time period of generating is 8–10 min.

Table 1

Air velocity and air pressure in the air channel for each variants

Versions	Dimensions (mm)	Velocity (m/s)	Pressure (Pa)
Version 1	450 x 400	0.163681	0.0133150
Version 2	450 x 450	0.153650	0.0134039
Version 3	450 x 500	0.142533	0.0121934
Version 4	450 x 550	0.132798	0.0111474
Version 5	450 x 600	0.125289	0.0104080
Version 6	500 x 400	0.165185	0.0155124
Version 7	500 x 450	0.149221	0.0121549
Version 8	500 x 500	0.137618	0.0110277
Version 9	500 x 550	0.128301	0.0101979
Version 10	500 x 600	0.121408	0.0094466

We designed the cross-section dimensions of ventilated air channel in 10 variants. The size and values of air pressures and air velocities are shown in the Table 1. The air pressure and air velocity values are from the second simulation. In the second simulation we used the values of air pressure what we obtained from the first simulation. We designed the church in the first simulation to get the properties of the wind on the surface church.

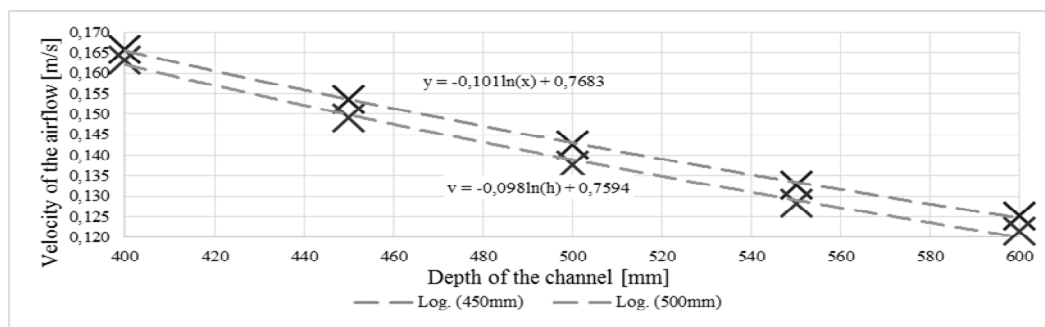

Fig. 6. Dependence of the velocity and depth of air channel

The first model was realized with an air flow of 3 m/s, during the summer with air temperatures approximating 25 °C. In the second model we used obtained values of pressure in monitored points, what represented the location of the inlets on the wall in the first model.

In this case we used a SST (Shear Streas Transport) numerical model. Temperature of the overall model is 25 °C (summer temperature). Apparent density of the air is 1.1845 kg/m³ and the dynamic viscosity of the air is 1.86159.10⁻⁵ kg/m.s. All section models of the channels are simulated by a wind flow of 3 m/s.

Results of the simulation. In the Figure 7 is displayed air velocity contour in the channel. Therefore in the final numerical simulation we used lower depth of the air channel with the enlarged width. Final cross-section dimensions of the air channel are 0.65 x 0.4 m.

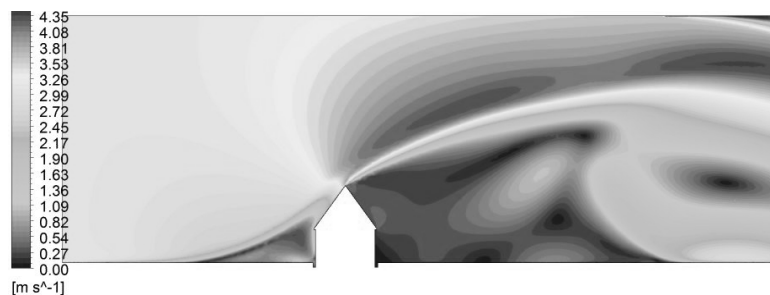

Fig. 7. Air velocity contour of open air channel model, result from software Ansys CFX

In the Figure 8 displayed contour of air in the open air channel around the church. The streamlines air is colored according to air velocity. Results obtained from the numerical simulation in software Ansys CFX are satisfactory in the complicated parts of the church as well as at the apse.

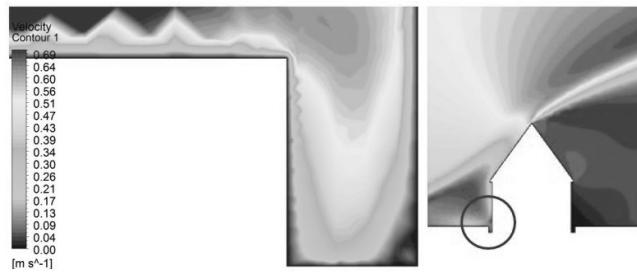

Fig. 8. The air contour of the open channel system: left – detail of air contour; right – full model of the air

Other variants for ventilated air channel

A. Closed system of the ventilated air channels with overpressure

The second type is the closed channel with overpressure air ventilation. The outdoor dry air enters the channel through the inlet pipes and the damp air is evaporated through the outlet openings. The advantage of this type is that the channel is hidden, only the inlets and outlets are visible on the façade or on the ground. The prefabricated cover plates are covered with gravel.

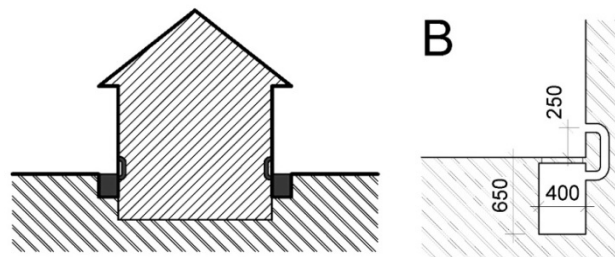

Fig. 9. Schema and dimensions of the closed channel with overpressure version

The geometry of the closed system with overpressure air ventilation is similar. The width of the channel was 0.4 m and the height was 0.6 m, and the cover plate was 0.05 m thick. The air channel is connected to the exterior air with pipes (inlets) with a diameter of 0.075 m. The heights of the inlets are 0.25 m on terrain. The outlets are situated on the terrain, the length of the outlets was 0.3 m and the width was 0.025 m.

B. Close system of the ventilated air channel with underpressure

The third type is the closed system with underpressure air ventilation. The underpressure in the channel is ensured with ventilation heads above the roof. The inlet openings are on the top of the channel or in the wall. The outlets are situated on the façade, this is the tall pipe, we can hide it in roof drain or on the façade only.

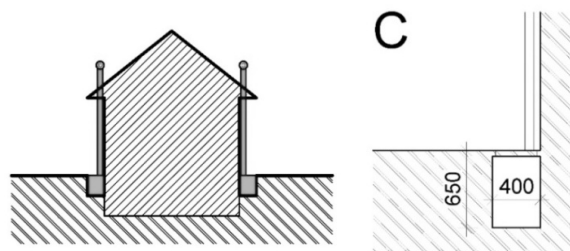

Fig. 10. Schema and dimensions of the closed channel with underpressure version

This version is similar, and the dimensions are same. The inlet pipes are replaced with the full height of the wall. The end of the pipes are above the roof with 0.5 m. The outlets in this case function as inlets, and the pipe above the roof as the outlet. The diameter of the pipe is 0.075 m.

C. System of ventilated plinth

The last one is the ventilated plinth. This type is the soft method of the ventilation, because between the plinth and the wall is a thin layer of air. The inlets are situated at the bottom of the plinth and the outlets on the top of the plinth.

In this case we used the basic dimensions for the simulation. The height of the prefabricated plates is 0.5 m and the thickness is 0.025 m. The air channel under the plates is 0.6 x 0.05 m. On the base there are the inlets with a height of 0.05 m and on the top of the plates are outlets with a height of 0.05 m.

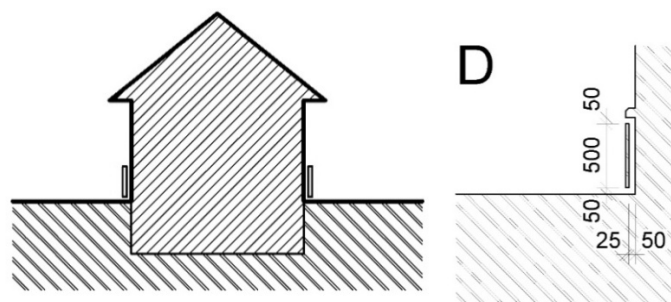

Fig. 10. Schema and dimensions of the ventilated plinth version

Conclusion. Many construction solution of air channels exist for historical buildings with damp problems in walls. The designed versions are the most widely used solutions as the: open air channel, closed air channel with overpressure, closed air channel with underpressure, ventilated plinth. We simulated 4 different versions, because these solutions are practiced in the reconstruction of historical buildings. From the 4 simulated versions is the closed air channel wit overpressure is the best solution for the specific case of Gemersky Jablonec. The versions are designed and set in accordance with regulations. Many literatures write about designing the right dimensions of air channels for example_ Balík M. in the book “Dehumidification of buildings”. As a result of the simulations we will compare and find the best solution. Obviously, not all versions or models are right for all environments. Modelling is necessary in every case and verification of its function.

Acknowledgments. This study was financially supported by Grant Agency of Slovak Republic to support of project No. 1/0307/16.

1. Young D. *Salt attack and rising damp – A guide to salt damp in historic and older buildings.* – 2008. – 10 p.
2. Brestovic T., Jasminska N., Pyszko R. *Measuring temperature of the atmosphere in the steelmaking furnace.* – 2015. – 10 p.
3. Alexander L.B., Armando M.A. *Aerodynamic analysys of buildings using numerical tools from computational wind engineering.* – 2007. – 10 p.
4. Balik M., et al. *Traditional details of buildings – rising damp.* – 2011. – 10 p.
5. Balik M., et al. *Dehumidification of buildings Vol. 2.* – 2008. – 10 p.
6. Havel M. *Procedure for remediation of damp masonry locks on the upper Vimperk.* – 2012. – 10 p.
7. Rencko T., Sedlakova A. *Assesment of underfloor ventilation of historic buildings.* – 2011. – 10 p.
8. Magulakova L., Lumnitzner E. *Contribution to the analysis of performance wind turbines.* – 2011. – 10 p.
9. Al-Hafzan Abdullah H., Anas Zafirof Abdullah H. *A analysis of dampness study on heritage building: a case study Iph old post office building and Suluh Budiman building.* – 2010. – 10 p.
10. Dufkková J. *Study of vertical profile of wind speed.* – 2012. – 10 p.
11. Kohta U. *masonry wall interior insulation retrofit embedded beam simulation.* – 2012. – 10 p.