

За допомогою методів математичного аналізу визначені амплітудно-фазові частотні функції бурильної колони для поступального руху при бурінні занурними двигунами. Проведено аналіз динамічних режимів процесу буріння свердловини як об'єкта керування. Запропоновано застосувати енергоінформаційний підхід до аналізу процесів в системі управління бурінням свердловини. Це дозволяє вирішити прикладну проблему визначення амплітудно-фазових характеристик бурильної колони залежно від глибини свердловини і використовувати в математичному забезпеченні автоматизованої системи управління

Ключові слова: процес буріння, амплітудно-фазові характеристики, бурильна колона, енергоінформаційний підхід, автоматизована система

С помощью методов математического анализа определены амплитудно-фазовые частотные функции бурильной колонны для поступательного движения при бурении погружными двигателями. Проведен анализ динамических режимов бурения скважины как объекта управления. Предложено применить энергоинформационный системный подход к анализу процессов в системе управления бурением скважины. Это позволяет решить прикладную проблему определения амплитудно-фазовых характеристик бурильной колонны в зависимости от глубины скважины и использовать в математическом обеспечении автоматизированной системы управления

Ключевые слова: процесс бурения, амплитудно-фазовые характеристики, бурильная колонна, энергоинформационный подход, автоматизированная система

UDC 681.514:622.24.03:539.3

DOI: 10.15587/1729-4061.2018.120544

ANALYSIS OF AMPLITUDE-PHASE FUNCTIONS OF THE DRILL STRING AS A COMPONENT OF AUTOMATION SYSTEM

V. Kropyvnytska

PhD, Associate Professor*

E-mail: vitalia.krop@gmail.com

T. Humeniuk

PhD*

E-mail: v_peschanska@gmail.com

N. Sabat

PhD*

G. Sementsov

Doctor of Technical Sciences, Professor**

E-mail: kafatp@ukr.net

*Department of Computer Systems and Networks***

**Department of automation

computer-integrated technologies***

***Ivano-Frankivsk National Technical University of Oil and Gas

Karpatska str., 15, Ivano-Frankivsk, Ukraine, 76019

1. Introduction

The process of drilling oil and gas wells is a non-reproducible nonlinear stochastic-chaotic process that evolves over time. This process functions under conditions of uncertainty in terms of parameters and structure of the object. Since such a system evolves over time, it is always open, that is, it exchanges energy, information, and matter with external environment. New temporal, spatial or functional structures may emerge within it. For example, the structure of design of a drill string is fractal. This means that the preceding fractal (one candle of a drill pipe) can exist without the next pipe, but not vice versa. That is why solving the problems on control over a dynamic process of deepening a well requires a global energoinformational approach, which includes consideration of the formation of structure of the model of a drill string and mathematical apparatus of synergetic theory of information.

The mode of operation of any drilling rig depends mainly on the stability and strength of the fractals of a drill string. The loss of stability of the straight section of the column leads to a deflection in the well, which in turn leads to its unsuitability.

In the process of deepening a well, a drill string is exposed to complex loads. Loads occur as a result of the simultaneous action of axial stresses of stretching and compression, as well as and torsion and bending. Part of these loads acts permanently, another part changes over time. The randomness of loads on the drill string is associated with possible longitudinal and torsional oscillations of the rock-crushing tool, as well as with a change in the geological conditions of drilling and other factors [1].

Longitudinal and torsional oscillations of the drill string occur simultaneously due to irregularity of the downhole of the well and rolling of the toothed surface of the bit cutters along the downhole. Longitudinal oscillations by their intensity are commensurate with torsional oscillations. However, the theory of torsional oscillations of a drill string has been studied to a lesser extent than that of longitudinal oscillations [2]. Technological models are not suitable for solving the tasks on automated control over the process of drilling. For this purpose, cybernetic mathematical models are required.

Thus, one of the relevant trends in the field of well drilling automation is to study modeling of the dynamics of drilling columns as elements of automation system.

2. Literature review and problem statement

Studies into drilling string dynamics are focused on computer simulation of the oscillations of bit rotation of a rotating drill string [3] and analysis of torsional oscillations of the column [4], which lead to the loss of stability in the motion of a column and to breaking its strength [5]. In this case, one of the most common assumptions is imposing the constraints on the magnitude of column deformation during modeling [6], which leads to the linearization of the mathematical model. Another assumption on the models of drill columns is limiting the degrees of freedom in column deformation; that is, there are separate studies into components of complex spatial deformation [7, 8]. All this leads to the limitation of mathematical models of drilling columns and significantly narrows understanding of the actual processes that occur in the system “drill string – borehole”. Main attention is paid to the construction of models for longitudinal and torsional oscillations of a drill string [9, 10]. The equation of longitudinal oscillations of the stretched part of the drill string takes the form [10]

$$ES \frac{\partial^2 U}{\partial x^2} + p(x, t) - m_1 \left(\frac{\partial^2 U}{\partial t^2} \right) = 0,$$

where E is the Young modulus; S is the cross-sectional area of pipes; m_1 is the mass per unit length of pipes; U is the vertical motion of the bit; $p(x, t)$ is the external longitudinal load; $m_1 \left(\frac{\partial^2 U}{\partial t^2} \right)$ are the forces of inertia.

The problem on torsional oscillations is identical to the previous one, which is why equation of torsional oscillations has a similar structure

$$GI_d \theta'' + m(x, t) - m_1 \left(\frac{\partial^2 \theta}{\partial t^2} \right) = 0,$$

where G is the module of the second kind; I_d is the torque of inertia of cross section of the column; θ is the turning angle of the column cross; $m(x, t)$ is the intensity of the external torque (bit – borehole);

$$m_1 = \frac{\gamma}{g} I_d$$

is the moment of inertia per unit length of pipe; γ is the weight per unit length of pipe.

In paper [11], based on profound theoretical research, authors constructed a nonlinear mathematical model of spatial deformation of the rotating column, with respect to finiteness of deformation. In addition to the transverse oscillations of the column that occur in two planes Oxz and Oyz , the authors considered a longitudinal shift of cross section along the column axis z .

Components of displacements $U(x, y, z, t)$, $V(x, y, z, t)$, $W(x, y, z, t)$ of the column, which is regarded as an oscillating rod, were obtained in the following form:

$$\begin{aligned} U(x, y, z, t) &= u(z, t), \\ V(x, y, z, t) &= v(z, t), \\ W(x, y, z, t) &= w(z, t) - \frac{\partial u(z, t)}{\partial z} x - \frac{\partial v(z, t)}{\partial z} y, \end{aligned} \quad (1)$$

where $u(z, t)$, $v(z, t)$ are the displacements of the center of bend of cross section along axes x and y as a result of bending, $w(z, t)$ is the translational displacement along the z axis.

In order to develop a mathematical model, they used the variation principle by Ostrogradsky-Hamilton, which made it possible to obtain equations for the potential energy of the rod

$$U_0 = \int_0^l \frac{G}{1-2\nu} \left(\begin{aligned} &\frac{1}{2} \left(S \left(\frac{\partial u}{\partial z} \right)^4 + S \left(\frac{\partial v}{\partial z} \right)^4 \right) + \\ &+ (1-\nu) \left(S \left(\frac{\partial w}{\partial z} \right)^2 + I_y \left(\frac{\partial^2 u}{\partial z^2} \right)^2 + \right. \\ &\left. + I_x \left(\frac{\partial^2 v}{\partial z^2} \right)^2 + 2I_{xy} \frac{\partial^2 u}{\partial z^2} \frac{\partial^2 v}{\partial z^2} \right) + \\ &+ S \left(\frac{\partial v}{\partial z} \right)^2 \frac{\partial w}{\partial z} + S \left(\frac{\partial u}{\partial z} \right)^2 \frac{\partial w}{\partial z} + \\ &\left. + \frac{5-6\nu}{2} S \left(\frac{\partial u}{\partial z} \right)^2 \left(\frac{\partial v}{\partial z} \right)^2 \right) dz \quad (2) \end{aligned} \right)$$

and kinetic energy with respect to the drill string rotation

$$T_{kin} = \frac{1}{2} \rho \int_0^l \left(\begin{aligned} &S \left(\frac{\partial u}{\partial t} \right)^2 + S \left(\frac{\partial v}{\partial t} \right)^2 + S \left(\frac{\partial w}{\partial t} \right)^2 + \\ &+ I_y \left(\frac{\partial^2 u}{\partial z \partial t} \right)^2 + 2I_{xy} \frac{\partial^2 u}{\partial z \partial t} \frac{\partial^2 v}{\partial z \partial t} + I_x \left(\frac{\partial^2 v}{\partial z \partial t} \right)^2 + \\ &+ I_p \omega^2 + S(u^2 + v^2) \omega^2 + 2\omega S v \frac{\partial u}{\partial t} - 2\omega S u \frac{\partial v}{\partial t} \end{aligned} \right) dz, \quad (3)$$

where

$$G = \frac{E}{2(1+\nu)}$$

is the shear modulus; I_x , I_y are the axial moments of inertia; I_{xy} is the centrifugal moment of inertia.

However, displacements of bending cross-section along the axes x , y , translational displacement along the z axis, axial moments of inertia I_x , I_y , centrifugal moment of inertia I_{xy} are not measured magnitudes in real time. This does not allow us to apply equations (2), (3) to measure potential and kinetic energy of the column *online* and use them for problems on control.

In addition, results of the simulation were verified by the author only for the column with a length of 150 m with constant cross-section, whereas cross-section of drill columns with a length, for example, of 4,500 m, is a variable magnitude.

All the above-mentioned limit the possibilities of employing known technological models and significantly narrows understanding of the realism of the processes that are simulated in the system “drill string – borehole” [12]. This is due to the fact that it is impossible to describe by determined methods effect of a large number of various factors that influence the processes in the well and complicate the motion of a column [13, 14]. It should be noted that well drilling at present employs diamond bits with a pass per one bit up to 6,000 m [15, 16]. When drilling with diamond bits PDC, oscillations of the column are significantly reduced [17], but the more important in this case are such factors as

hydrodynamic processes, pressure [18], temperature [19], and others.

However, the issues of modeling a drill string require more detailed studies. That is why it is a promising task to solve a problem on improving the description of the motion of a column in the system “drill string – borehole.” It is applied in optimization problems on control process over drilling oil and gas wells based on an energoinformational approach. The main focus in this case should be on studying the amplitude-phase characteristics of a drill string depending on the depth of the well. In particular, it is necessary to employ amplitude-phase characteristics for the mathematical substantiation of the automated system of control over drilling under online mode.

3. The aim and objectives of the study

The aim of present study is to model dynamics of drilling columns as elements of the automation system. This will make it possible to solve the task on automated control over a well drilling process depending on the structure of the drill string, change in the geological conditions of drilling, and other factors.

To accomplish the set aim, the following tasks have been formulated:

- to determine amplitude-phase function of a drill string for the effort, which it transmits to the well bottom while drilling with immersed engines, when the drill string is not rotating;
- to analyze dynamic modes when deepening a well as the control object based on the synergetic theory of information.

4. Analysis of dynamic properties of the drill string with the downward translational motion

Control over a rotary drilling process is executed by selecting and maintaining three basic parameters that characterize drilling mode: axial effort for bit, frequency of its rotation and the volume of washing fluid. In most cases, control is carried out by increasing or decreasing axial force on the bit that is passed through the column of drill pipes and sometimes by changing the volume of washing fluid.

While deepening a well, the drill string is set not only in rotational motion, but also in the downward translational motion. In this case, it operates under the influence of both static and dynamic loads – the force of its own weight, the reaction of well, friction force, the effort of feed, torque, centrifugal forces. Under their influence the column undergoes mechanical stresses and elastic deformations, which are transmitted along the length of the column not instantaneously but at some delay, due to the translational motion.

The dynamic scheme of a drilling rig shows a modeled scheme of the drill string in the form of a rod (Fig. 1). Given this, the assumption for longitudinal oscillations and translational motion can be formulated as:

- drilling is performed using an immersed engine (a turbodrill, an electric drill);
- a vertical section of the well is considered;

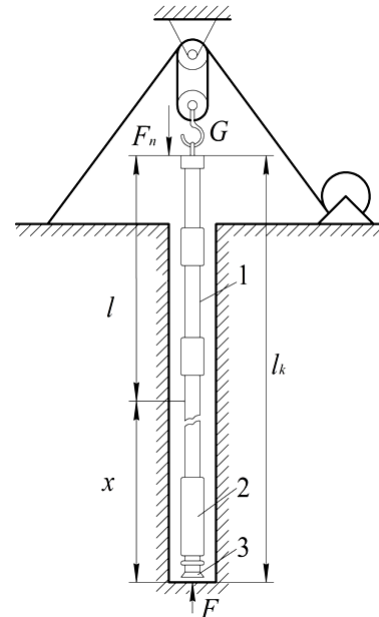

Fig. 1. Modeled scheme of drill string:
1 – drill string; 2 – immersed engine; 3 – bit

- the effort of feed applied to the upper end of the drill string has two components – constant \bar{F}_f and variable \tilde{F}_f , which change over time in line with the harmonious law;
- mechanical drilling speed at the well bottom also has two components – constant \bar{V} and variable \tilde{V} ;
- constant components of effort at the well bottom \bar{F} and of mechanical drilling speed \bar{V} are determined from known formulae of the balance of forces:

$$\bar{F} = G - \bar{F}_f \pm \tilde{F}_f, \tag{4}$$

$$\bar{V} = k_f \bar{F}, \tag{5}$$

where G is the weight of the drill string; \bar{F}_f is the force of friction; \tilde{F}_f is the effort of feed; k_f is the coefficient of proportionality;

- forces of friction of the drill string against borehole walls and the washing fluid are evenly distributed along the length of the column and are the functions of speed of the translational motion of column;
- losses caused by the longitudinal deformation of column are proportional to the efforts that create deformation.

When drilling with immersed engines (screw engines, electric drills), when the column is immovable, these assumptions are valid for vertical wells with a depth of 2,000–3,000 m [20].

Note that dependence (5) of mechanical drilling speed on axial effort is nonlinear. That is why coefficient of proportionality $k_n=var$. Diagrams of informational models for the relation between mechanical drilling speed with axial effort and polynomial model for coefficient k when drilling a well by the electric drill E215-8 with a roller cone bit to a depth of 2,300 m are shown in Fig. 2, 3, respectively. To construct informational dependences, we used a sample of data obtained as a result of passive observation of the process of deepening the well RG-801D. We registered the following while deepening the well: axial load on the bit, temperature of the drilling solution, pass per bit, time T of drilling 1 m of rock, speed of bit rotation.

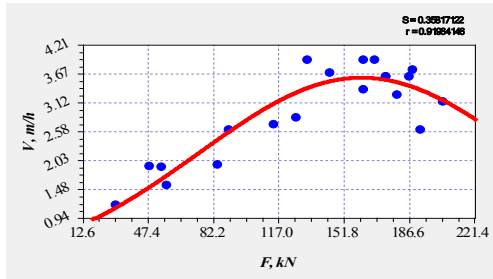
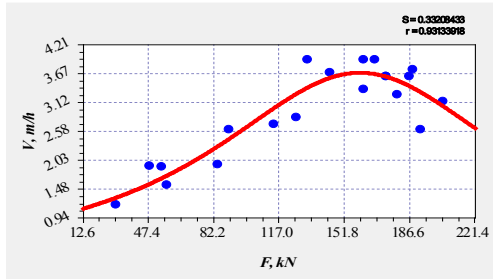
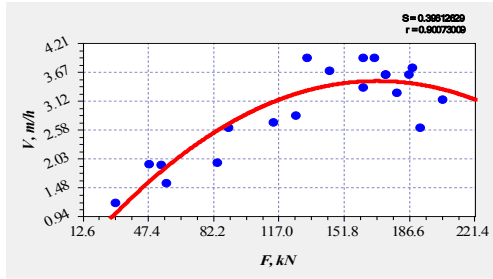

Fig. 2. Informational models for the relation between mechanical drilling speed with axial effort: a – quadratic; b – inversely-quadratic; c – Gaussian

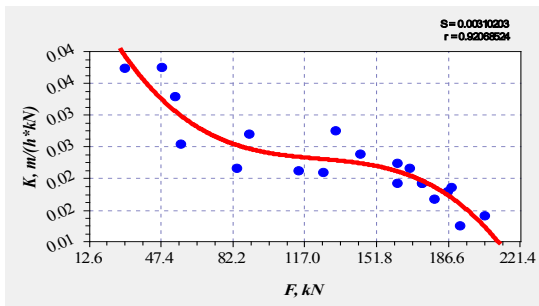

Fig. 3. Informational polynomial model of 3rd degree for coefficient *k*

Equations of the considered models take the form (Table 1).

In order to determine statistical characteristics of fluctuations in axial effort $F(t)$ at manual and automated control, we shall use experimental data obtained during operation of the system Autodriller [21]. The process of drilling was at a depth of 2,400 m, with the 8 1/2” diamond bits PDC in the region of Entre Lomas.

By employing the MathCad software, we shall construct dependence charts of $F(t)$ at manual (Fig. 4) and automated control (Fig. 5), $F \in [0; 1.0]$, which corresponds to $F \in [0; 200]$ kN.

Table 1

Informational models		
Model name	Mathematical dependence	Coefficient values
Quadratic	$y=a+bx+cx^2$	$a=-1.83044656885E-001$ $b=4.36663652797E-002$ $c=-1.29108661361E-004$
Inversely-quadratic	$y=1/(a+bx+cx^2)$	$a=1.00224923612E+000$ $b=-9.14367894753E-003$ $c=2.85825994330E-005$
Gaussian	$y = ae^{-\frac{(x-b)^2}{2c^2}}$	$a=3.60440068510E+000$ $b=1.60768766283E+002$ $c=8.64276577356E+001$
Polynomial model of 3rd degree	$y=a+bx+cx^2+dx^3$	$a=6.18322894057E-002$ $b=-8.30871654378E-004$ $c=6.47368524835E-006$ $d=-1.74522337315E-008$

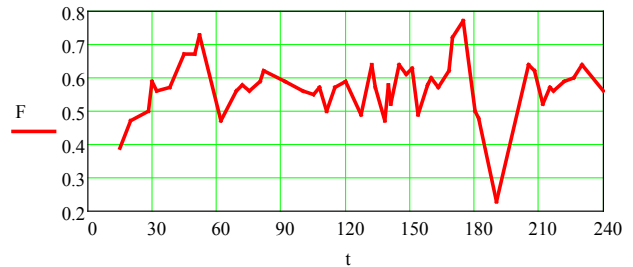

Fig. 4. Dependence chart of $F(t)$ at manual control

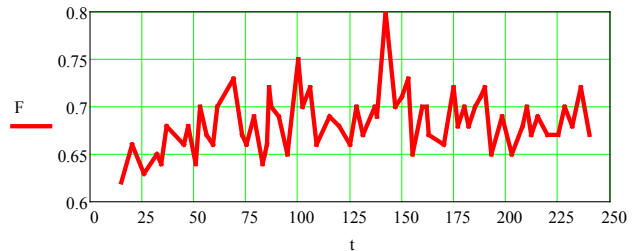

Fig. 5. Dependence chart of $F(t)$ at automated control

Properties of random signals $F(t)$ will be described employing concepts of the theory of probability and mathematical statistics (Table 2).

Table 2

Statistical characteristics of axial effort $F(t)$					
Control mode	Estimates			Distribution law	Autocorrelation function
	mathematical expectation	variance	Root-mean-square deviation		
manual	0.561	$7.051 \cdot 10^{-3}$	0.084	normal	$1.647e^{-3.742t}$
automated	0.683	$8.679 \cdot 10^{-4}$	0.029	normal	$1.65e^{-3.726t}$

The equation of autocorrelation function at manual and automated control was obtained using the software CurveExpert.

Thus, the equation of autocorrelation function for axial effort F at manual control takes the following form:

$$R(\tau) = 1.647e^{-3.742\tau}.$$

Find spectral density

$$S(\omega) = \frac{12.326}{14.003 + \omega^2}.$$

Find a transfer function of the forming filter and split it into real and imaginary parts in order to construct APC of the forming filter using the MathCad software (Fig. 6).

$$W_{fil}(j\omega) = \frac{\sqrt{2D\alpha}}{\alpha + j\omega},$$

$$W_{fil}(j\omega) = \frac{3.511}{3.742 + j\omega},$$

$$P(\omega) = \frac{13.138}{14.003 + \omega^2},$$

$$Q(\omega) = \frac{3.511\omega}{14.003 + \omega^2}.$$

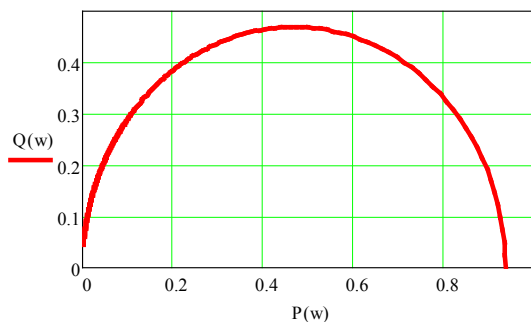

Fig. 6. APC chart of the forming filter for axial effort *F* at manual control

The equation of autocorrelation function for axial effort *F* at automated control takes the following form:

$$R(\tau) = 1.65e^{-3.726\tau}.$$

Find spectral density

$$S(\omega) = \frac{12.296}{13.883 + \omega^2}.$$

Find a transfer function of the forming filter and split it into real and imaginary parts in order to construct APC of the forming filter (Fig. 7).

$$W_{fil}(j\omega) = \frac{\sqrt{2D\alpha}}{\alpha + j\omega},$$

$$W_{fil}(j\omega) = \frac{3.507}{3.971 + j\omega},$$

$$P(\omega) = \frac{13.926}{13.883 + \omega^2},$$

$$Q(\omega) = \frac{3.507\omega}{13.883 + \omega^2}.$$

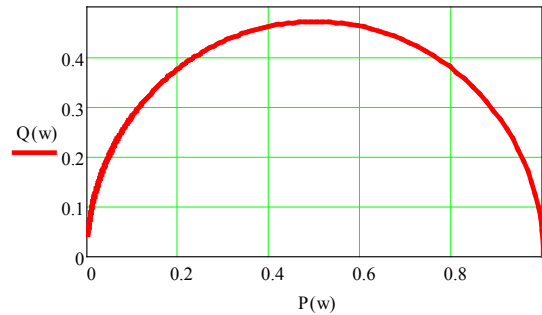

Fig. 7. APC chart of the forming filter for axial effort *F* at automated control

Under the influence of variable component of the axial effort, each element of the drill string will create longitudinal oscillations, which lead to the loss of dynamic stability of the drill string. The loss of the dynamic stability of the drill string leads to the premature failure of pipes, damage to bit and machinery of the drilling rig.

In paper [9], authors examined conditions for the violation of dynamic stability for the case when the magnitude of the axial effort to a bit is very small compared to the weight of the column. However, the cases when the pressed section of a column is quite large require some clarification. This is due to the fact that the pressed section of a column even at small length in statics loses stability and twists in a spiral. In this case, the pressed section of a drill string has no its own frequency of oscillations and does not alter the shape of its bend at a change in the speed of rotation. Oscillations in the system are caused by a reverse positive link. It exists only at the stretched section of the drill string. In addition, the longitudinal rigidity of the stretched and compressed sections of the column is different, which is why the column is no longer homogeneous.

Under condition of disregarding the forces of friction and losses from elastic deformations, elements of the drill string can be described by the following system of equations [2]:

$$\frac{d\tilde{F}_x}{dx} = j\omega m \tilde{V}_x, \tag{6}$$

$$\frac{d\tilde{V}_x}{dx} = j \frac{\omega}{(EF)} \tilde{F}_x, \tag{7}$$

where \tilde{F}_x is the variable component of effort in the column cross-section $\tilde{F}_x = F_x e^{j\omega x}$; $j\omega$ is a complex variable; ω is the frequency; \tilde{V}_x is the variable component of mechanical drilling speed; m is the mass per unit length of the column; E is the Young modulus; (EF) is the rigidity of the column cross-section; x is the variable distance from the bit to any point of the drill string.

Upon differentiation of equations (6) and (7) for x , we obtain:

$$\frac{d^2\tilde{F}_x}{dx^2} = -\frac{m}{(EF)} \omega^2 \tilde{F}_x, \tag{8}$$

$$\frac{d^2\tilde{V}_x}{dx^2} = -\frac{m}{(EF)} \omega^2 \tilde{V}_x. \tag{9}$$

By solving a system of equations (8) and (9) relative to \tilde{F}_x and \tilde{V}_x , we obtain:

$$\tilde{F}_x = 0.5(\tilde{F} + \tilde{V}z_{x0})e^{j\delta x} + 0.5(\tilde{F} + \tilde{V}z_{x0})e^{-j\delta x}, \quad (10)$$

$$\tilde{V}_x = 0.5\left(\tilde{V} + \frac{\tilde{F}}{z_{x0}}\right)e^{j\delta x} + 0.5\left(\tilde{V} - \frac{\tilde{F}}{z_{x0}}\right)e^{-j\delta x}, \quad (11)$$

where \tilde{F} is the variable component of axial effort on the well bottom, which is equal to \tilde{F}_x , at $x=0$; \tilde{V} is the variable component of mechanical drilling speed that is equal to \tilde{V}_x , at $x=0$; δ is the constant of oscillation attenuation, which equals

$$\delta = \omega \left[\frac{m}{(EF)} \right]^{0.5},$$

z_{x0} is the wave resistance of column to longitudinal oscillations, $z_{x0} = [m(EF)]^{0.5}$.

It follows from equations (10), (11) that at any point along the axis of the drill string effort \tilde{F}_x and mechanical drilling speed \tilde{V}_x can be represented as the sum of two vectors.

The first vector of the incident wave with an increase in x rotates counterclockwise. The second vector of the reflected wave rotates clockwise. If the count of the current coordinate is performed not from the well bottom, but from the beginning of the drill string ($x=l_k-l$, where l_k is the length of the drill string), then equations (10), (11) at $l_k \rightarrow \infty$ will take the following form:

$$\tilde{F}_l = F_n e^{-j\delta l}, \quad (12)$$

$$\tilde{V}_l = \frac{F_n}{z_0} e^{-j\delta l}, \quad (13)$$

where l is the current value of coordinate $l=l_k-x$.

It follows from equations (12), (13) that the drill column whose length is $l_k \rightarrow \infty$ lacks the reflected wave.

Theoretically, vectors of effort \tilde{F}_l and speed \tilde{V}_l with an increase in l continuously turn towards lagging while their modules remain unchanged. In fact, modules of vectors \tilde{F}_l and \tilde{V}_l with increasing l will decrease as a result of the influence of friction forces on a drill string and losses of energy for the deformation of walls of the pipes.

In order to qualitatively assess the impact of these factors on the character of motion of the drill string, we shall record equations (6) and (7) by analogy to equations for electric chain with distributed parameters [14]:

$$\frac{d\tilde{F}_x}{dx} = (j\omega m + r_v)\tilde{V}_x = z_v \tilde{V}_x, \quad (14)$$

$$\frac{d\tilde{V}_x}{dx} = \left(j \frac{\omega}{EF} + q_F \right) \tilde{F}_x = y_F \tilde{F}_x, \quad (15)$$

where $z_v \tilde{V}_x$ is the gain of force of friction per unit length of the drill string; $q_F \tilde{F}_x$ is the gain in linear speed per unit length of the drill string, caused by the losses of energy for deformation;

$$z_v = j\omega m + r_v;$$

$$y_F = j \frac{\omega}{EF} + q_F.$$

By solving equations (14), (15), we shall obtain:

$$\tilde{F}_x = 0.5(\tilde{F} + \tilde{V}z_{10})e^{\delta_1 x} + 0.5(\tilde{F} - \tilde{V}z_{10})e^{-\delta_1 x}, \quad (16)$$

$$\tilde{V}_x = 0.5\left(\tilde{V} + \frac{\tilde{F}}{z_k}\right)e^{\delta_1 x} + 0.5\left(\tilde{V} - \frac{\tilde{F}}{z_k}\right)e^{-\delta_1 x}, \quad (17)$$

where

$$z_{10} = \left(\frac{z_v}{y_F} \right)^{0.5}$$

is the wave resistance of the drill string; δ_1 is the attenuation constant, $\delta_1 = (z_0 y_F)^{0.5}$.

After replacing $\tilde{x} = l_k - l$ at $l_k \rightarrow \infty$, equations (16), (17) will be written in the following form:

$$\tilde{F}_l = F_n e^{-\delta_1 l}, \quad (18)$$

$$\tilde{V}_l = \frac{F_n}{z_{10}} e^{-\delta_1 l}. \quad (19)$$

Taking the ratio (18), (19), we shall obtain wave resistance of drill string:

$$\frac{\tilde{F}_l}{\tilde{V}_l} = z_{10}. \quad (20)$$

Thus, at $l_k \rightarrow \infty$, ratio of vector \tilde{F}_l to vector \tilde{V}_l in any drill string cross-section is equal to wave resistance. This means that if such a drill string is cut and the part that remained and has a certain length is used to perform drilling under conditions when

$$\frac{\tilde{F}}{\tilde{V}} = \frac{\Delta \tilde{F}}{\Delta \tilde{V}} k_n = z_{10},$$

there will be no reflected wave. Such a mode of operation of the drill string and deepening process is the most favorable, since in this case, due to damping the properties of the well bottom, the reflected wave would be fully attenuated with its energy being used only for useful work.

However, ensuring the equality of transfer coefficient k_n of the set "well bottom – bit" of wave resistance of drill string z_{10} for rocks with different physical-mechanical and abrasive properties is almost impossible. This is due to the fact that even when drilling in homogeneous rocks with $F = \text{const}$ and $\omega = \text{const}$ coefficient $k_n = \text{var}$ owing to the wear of bit. That is why there is almost always a reflected wave. Reflected wave reaches the upper end of the drill string and affects performance of the drive of a drilling rig feed as a generator of harmonic oscillations.

In this case, such characteristic modes of drill string operation are possible:

- lower end of the drill string is fixed ($\tilde{V} = 0$; $\tilde{V} = 0$);
- lower end of the drill string is free ($\tilde{F} = 0$; $k_n = 0$).

For the first case, at $\tilde{V} = 0$, equations (11) and (12) take the following form:

$$\tilde{F}_{x(\tilde{V}=0)} = 0.5\tilde{F}(e^{\delta_1 x} + e^{-\delta_1 x}), \quad (22)$$

$$\tilde{V}_{x(\tilde{V}=0)} = 0.5 \frac{\tilde{F}}{z_{10}} (e^{\delta_1 x} - e^{-\delta_1 x}). \quad (23)$$

Magnitude $\frac{\tilde{F}_x}{\tilde{V}_x}$ at $\tilde{V} = 0$ will be denoted as z_{0k} and called resistance of the column when its end is fixed.

Numeric value of this magnitude is equal to

$$z_{0k} = z_{10} \text{cth}(\delta_1 x), \tag{24}$$

where

$$\text{cth}(\delta_1 x) = \frac{e^{\delta_1 x} + e^{-\delta_1 x}}{e^{\delta_1 x} - e^{-\delta_1 x}} = \frac{1}{\text{th}(\delta_1 x)},$$

is the hyperbolic cotangent.

For the second case, at $\tilde{F} = 0$, effort \tilde{F}_x and speed \tilde{V}_x in any column cross-section are derived from

$$\tilde{F}_{x(\tilde{F}=0)} = 0.5\tilde{V}z_{10} (e^{\delta_1 x} - e^{-\delta_1 x}), \tag{25}$$

$$\tilde{V}_{x(\tilde{F}=0)} = 0.5\tilde{V} (e^{\delta_1 x} + e^{-\delta_1 x}). \tag{26}$$

Ratio $\frac{\tilde{F}_x}{\tilde{V}_x}$ at $\tilde{F} = 0$ will be denoted as z_{kc} and called the resistance of drill string when its end is free.

Numeric value of this magnitude is equal to

$$z_{kc} = z_{10} \text{th}(\delta_1 x), \tag{27}$$

where

$$\text{th}(\delta_1 x) = \frac{e^{\delta_1 x} - e^{-\delta_1 x}}{e^{\delta_1 x} + e^{-\delta_1 x}},$$

is the hyperbolic cotangent.

Considered equations allow us to experimentally determine from (24) and (27) wave resistance of the drill string

$$z_{10} = (z_{0k} z_{kc})^{0.5} \tag{28}$$

and the constant of damping

$$\delta_1 = (z_v y_f)^{0.5} = \alpha + j\beta. \tag{29}$$

Based on the analysis of possible modes of drill string operation, one can formulate the following recommendations for improving conditions of work.

The most unfavorable mode in terms of levels of mechanical stresses in the column is the one at which $\tilde{V} \approx 0$.

When drilling in hard rocks, especially when using a blunt roller cone bit, at $k_n \rightarrow \infty$ and $\tilde{V} \rightarrow 0$, it is appropriate to apply the cushion subs [10], which makes it possible to significantly reduce level of the reflected wave from mechanical stresses. Reflected wave of mechanical stresses is always present in the drill string [24]. Reflected wave APFects the mechanism of feeding a drilling rig. To create conditions that contribute to damping the longitudinal oscillations, it is required that the feed drive has absolutely soft mechanical characteristics $n=f(M)$. This ensures the independence of effort from the feed speed. This means that the feed effort, which is set by the drive, will remain unchanged, or will change by the assigned law, regardless of the speed of motion of the upper end of a drill string.

Now we shall determine the amplitude-phase function (APF) of the drill string for effort F , transmitted by it.

To do this, we shall apply equation (16), accepting that $\tilde{V} = \tilde{F} / k_n$ and $x=l_k$.

Then the feed effort at the beginning of the column will equal to

$$\tilde{F}_{l_k} = \tilde{F}_n = 0.5\tilde{F} \left[\left(1 + \frac{z_{10}}{k_n} \right) e^{\delta_1 l_k} + \left(1 - \frac{z_{10}}{k_n} \right) e^{-\delta_1 l_k} \right]. \tag{30}$$

Next, we shall derive APF of the drill string from equation (29)

$$W_{DC}(j\omega) = \frac{\tilde{F}}{\tilde{F}_n} = \frac{2}{\left(1 + \frac{z_{10}}{k_n} \right) e^{\delta_1 l_k} + \left(1 - \frac{z_{10}}{k_n} \right) e^{-\delta_1 l_k}}. \tag{31}$$

In the case of α in expression (29) for the constant attenuation being zero, then

$$W_{DC}(j\omega) = \frac{\cos(\omega\tau_d) - j\rho \sin(\omega\tau_d)}{\cos^2(\omega\tau_d) + \rho^2 \sin^2(\omega\tau_d)}, \tag{32}$$

where ρ is the degree of consistency in parameters of the drill string with parameters of the link “bit – rock”, $\rho = z_{1c}/k_n$; τ_d is the lag in transfer influences $\tau_d = l_k [m/(EF)]^{0.5}$.

APF (32) can be represented as the sum of the real and imaginary parts

$$W_{DC}(j\omega) = P_{DC}(\omega) + jQ_{DC}(\omega),$$

where

$$\left. \begin{aligned} P_{DC}(\omega) &= \text{Re} W_{DC}(j\omega) = \frac{\cos(\omega\tau_d)}{\cos^2(\omega\tau_d) + \rho^2 \sin^2(\omega\tau_d)}, \\ Q_{DC}(\omega) &= \text{Im} W_{DC}(j\omega) = -\frac{\rho \sin(\omega\tau_d)}{\cos^2(\omega\tau_d) + \rho^2 \sin^2(\omega\tau_d)}. \end{aligned} \right\} \tag{33}$$

Expression (33) can be considered as the equation of amplitude-phase characteristic $W(j\omega)$, assigned in the parametric form in the system of coordinates $P_{DC}(\omega)$ and $jQ_{DC}(\omega)$. The role of a third variable (parameter) belongs to frequency ω .

Expression for amplitude-frequency characteristic $A_{DC}(\omega)$ can be derived from equation

$$A_{DC}(\omega) = |W_{DC}(j\omega)| = \sqrt{P_{DC}^2(\omega) + Q_{DC}^2(\omega)} = \frac{1}{\sqrt{\cos^2(\omega\tau_d) + \rho^2 \sin^2(\omega\tau_d)}}.$$

Expression for the phase-amplitude characteristic is derived from formula

$$\begin{aligned} \phi_{DC}(\omega) &= \text{arctg} W_{DC}(j\omega) = \\ &= \text{arctg} \left(\frac{Q_{DC}(\omega)}{P_{DC}(\omega)} \right) = -\text{arctg} \frac{\rho \sin(\omega\tau_d)}{\cos(\omega\tau_d)}. \end{aligned}$$

Thus, APF of the drill string for effort is determined by length of the column l_k , constant of attenuation time δ_1 , wave resistance z_{10} , proportionality coefficient k_n .

It follows from equation (32) that APF, and, therefore, dynamic properties of the drill string, largely depend on the degree of consistency between parameters of the column and parameters of the link “bit – rock”. In particular, if $\rho \approx 0$, which is matched with $k_n \approx \infty$, then APF (32) has resonance frequencies [24, 25]:

$$\omega = \frac{n\pi}{2\tau_d}, \tag{34}$$

where n is any number, $n=1, 2, 3 \dots$

Longitudinal oscillations of column with such frequencies are unacceptable because they are accompanied by large fluctuations in axial effort to the bit and create prerequisites for longitudinal bending and deflection of the well.

However, in the case when a bit feed drive has absolutely soft mechanical characteristics, the second constituent of equation (30), corresponding to the reflected wave of mechanical stresses, at $x=l_k$, is equal to zero. Then APF equation (31) will take the following form

$$W_{DC}(j\omega) = \frac{2}{1+\rho} e^{-\delta_1 l_k} \tag{35}$$

or

$$W_{DC}(j\omega) = \frac{2e^{-\alpha l_k}}{1+\rho} e^{-j\omega \sqrt{\frac{m}{EF}} l_k}, \tag{36}$$

where

$$\alpha \equiv \frac{z_V}{2z_{10}} + \frac{q_F z_{10}}{2}.$$

Record a transfer function

$$W(s) = \frac{2e^{-\alpha l_k}}{1+\rho} e^{-s \sqrt{\frac{m}{EF}} l_k} = ke^{-s\tau},$$

where

$$k = \frac{2e^{-\alpha l_k}}{1+\rho}, \quad \tau = \sqrt{\frac{m}{EF}} l_k.$$

Equation (36) shows that in the case of using at a drilling rig a feed drive with absolutely soft mechanical characteristics, and $\rho \approx 1$, a drill string is the link with a sheer delay. In this case, module of vector $W_{DC}(j\omega)$ decreases with increasing length of the column, while the argument increases both with increasing length of the column and with growing frequency of forced oscillations.

APC equation (35) also indicates the absence of resonance frequencies and shows monotonous character of oscillation attenuation in a column in the absence of change in the control action – axial effort to the bit.

Matching the parameters of pipes in a drill string to parameters of the link “bit – rock” can be performed by selecting the appropriate types of drill pipes, as well as by using the cushion subs [10]. If the latter’s parameters are chosen as

$$k_n = \frac{\Delta \bar{F}}{\Delta \bar{V} + \Delta V_\alpha} = z_{10}, \tag{37}$$

where V_α is the gain in speed of the translational motion of the end of the drill string through elastic properties of the shock absorber. Its application when drilling hard rocks would make it possible to increase the degree of consistency of ρ and thereby significantly reduce the amplitude of oscillations of the variable component of axial load on the bit.

We shall analyze effect of the degree of consistency ρ and the magnitude of a lag (time of delay) on APF of a drill string

(32). For this purpose, we shall construct amplitude-phase characteristics (APC) employing the MatLab software.

Table 3

APC of drill string for degree of consistency $\rho=0.6$ and lag $\tau_d=1, 2, 4, 6, 8, 10$ seconds

Lag magnitude, seconds	Starting section of drill string APC	Drill string APC
1	$\omega=0, 0.002\dots 1.575$ 	$\omega=0, 0.002\dots 500$
2	$\omega=0, 0.002\dots 0.785$ 	$\omega=0, 0.002\dots 500$
4	$\omega=0, 0.002\dots 0.39$ 	$\omega=0, 0.002\dots 500$
6	$\omega=0, 0.002\dots 0.26$ 	$\omega=0, 0.002\dots 500$
8	$\omega=0, 0.002\dots 0.1975$ 	$\omega=0, 0.002\dots 500$
10	$\omega=0, 0.002\dots 0.158$ 	$\omega=0, 0.002\dots 500$

An analysis of APC given in Table 3 revealed that the lag insignificantly affects the shape of the drill string APC.

Table 4 gives APC of the drill string for different degrees of consistency ρ at constant delay $\tau_d=2$ seconds.

Table 4

APC of drill string for lag $\tau_d=2$ seconds and degree of consistency $\rho=1, 0.8, 0.4, 0.2, 0.1$

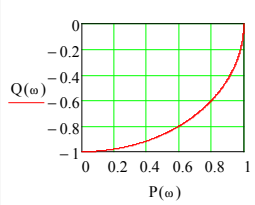
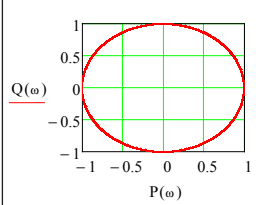
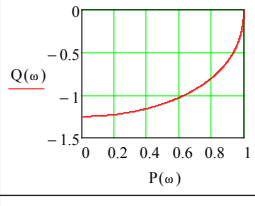
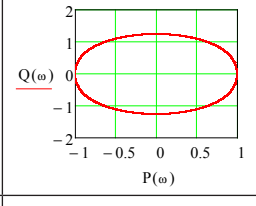
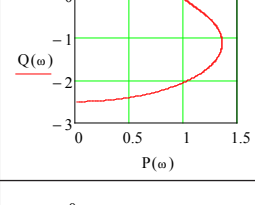
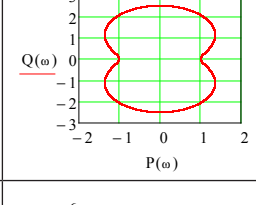
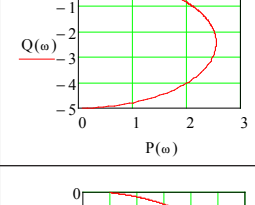
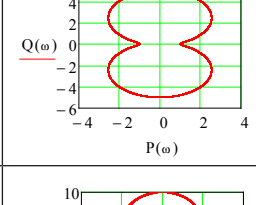
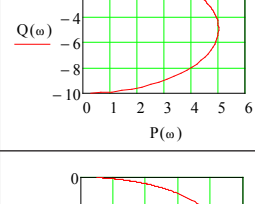
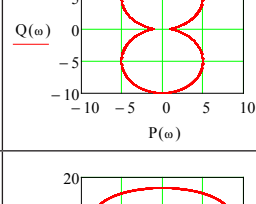
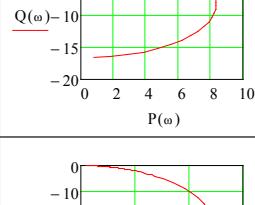
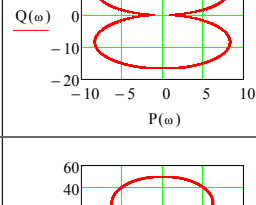
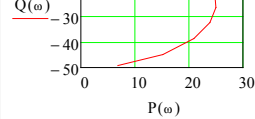
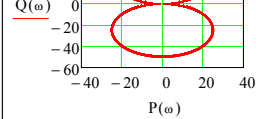
Degree of consistency, ρ	Starting section of drill string APC $\omega=0, 0.002...0.785$	Drill string APC $\omega=0, 0.002...500$
1		
0.8		
0.4		
0.2		
0.1		
0.06		
0.02		

We see that APC of the drill string significantly depends on the degree of consistency ρ .

5. Analysis of dynamic modes of well drilling process as an element of automation system based on the synergetic theory of information

According to the synergetic theory of information [26], information I_A that characterizes the process of drilling a well as dynamic system A , which consists of $m(A)$ elements, is divided into reflected I_B and non-reflected I_H components.

The reflected component of information I_B characterizes structural orderliness of the entire well drilling system and it is called the additive negentropy [25]. The non-reflected component of information I_H is the measure of structural chaos and it is called the entropy of reflection. In this case, the following informational relation holds:

$$I_A = I_B + I_H. \tag{38}$$

In addition

$$I_A = \log_2 m(A). \tag{39}$$

Expression (38) shows the inseparable interconnection between combinatorial, probabilistic and synergetic approaches.

We shall note that this informational feature of the process of drilling oil and gas wells makes it possible to employ the so-called R -function as a generalized characteristic of relation between order and chaos [25]

$$R = \frac{I_B}{I_H}. \tag{40}$$

In general, if $R>1$, the dynamic system of drilling is dominated by order, but if $R<1$, then there is chaos.

In order to determine values for I_B and I_H for any drilling rig as dynamic system A with a number of elements $m(A)$, we shall divide by set N of its parts: B_1, B_2, \dots, B_N .

Each part has a number of elements $m(B_1), m(B_2), \dots, m(B_N)$, the sum of which is equal to

$$\sum_{i=1}^N m(B_i) = m(A). \tag{41}$$

The number of elements N will be derived from the Sturges formula $N=1+3.321\lg(A)$.

Using the above definitions, formulae for additive negentropy I_B and entropy of non-reflection I_H using the entropy measure by C. Shannon take the following form [26, 27]:

$$I_B = -\sum_{i=1}^N \frac{m(B_i)}{m(A)} \log_2 m(B_i), \tag{42}$$

$$I_H = -\sum_{i=1}^N \frac{m(B_i)}{m(A)} \log_2 \frac{m(B_i)}{m(A)}, \tag{43}$$

where $m(A)$ is the total number of elements within system A ; $m(B_i)$ is the number of elements in the composition of the i -th element B_i .

Informational-synergetic functions (39), (42), (43) allow us to highlight the five modes of operation in the drilling

process [26]. Such regimes are equilibrium, ordered, sorted-chaotic, randomly-ordered, chaotic. These modes can be described by the following logical rules:

R1: if $\sqrt{m(A)} \leq N \leq 0.25m(A) + 1$ and $I_B = I_H$ then equilibrium,

R2: if $N < \sqrt{m(A)}$ and $I_B > I_H$ then ordered,

R3: if $\sqrt{m(A)} \leq N \leq 0.25m(A) + 1$ and $I_B > I_H$ then sorted-chaotic,

R4: if $\sqrt{m(A)} \leq N \leq 0.25m(A) + 1$ and $I_B < I_H$ then randomly-ordered,

R5: if $N > 0.25m(A)$ and $I_B > I_H$ then chaotic.

Therefore, using the apparatus of synergetic theory of information allows us based on actual experimental data on drilling a well to analyze dynamic modes of deepening the wells and to determine their dynamic stability. Dynamic stability can be ensured along with the tuning of parameters of drilling mode by introducing the cushion sub to the fractal structure of the column of drill pipes.

6. Discussion of results of examining amplitude-phase functions of the drill string as an element of automation

The benefit of results obtained in the present study is that they contribute to solving a problem of control over a dynamic process of deepening the wells taking into consideration changes in the algorithmic structure of the control object. This is achieved through the adaptation of control system in real time to the changes in length of the column, in a constant of damping time, wave resistance, and a proportionality coefficient between axial effort and mechanical drilling speed. Since APF, and, therefore, dynamic properties of the drill string, largely depend on the degree of consistency between parameters of the column and parameters of the link “bit – rock”, we propose to use at drilling installation a feed drive filing with absolutely soft mechanical characteristics.

Applying the apparatus of synergetic theory of information allows us based on actual experimental data on drilling a well under online mode to analyze dynamic properties of the well and to determine their dynamic stability. At a constant magnitude of axial effort on the bit, the column is devoid of resonance frequencies with damping oscillations demonstrating a monotonous character. To match parameters of pipes in the drill string to parameters of the link “bit – rock”, it is advisable to introduce a cushion sub to the system of control over the process of drilling. This would increase the degree of consistency of ρ and thereby significantly reduce the amplitude of oscillations in the variable component of axial load on the bit.

The shortcoming is that the energy of drill string oscillations is unattainable to be measures and to be utilized in a control system over drilling a well. Therefore, in order to characterize dynamic properties of the drilling process, it is advisable to apply the property of persistence. This phenomenon can be employed to solve the tasks on the prediction and early detection of deviations of technological process from the norm in real time.

Research results could be applied in the adaptive automated control systems for the process of drilling oil and gas wells using a turbodrill and an electric drill.

Present study is subject to improvement in the future with the aim of creating intelligent system to support decision-making processes to control the process of drilling deep wells.

7. Conclusions

1. Based on the use of method of mathematical analysis, as well as provisions of the modern theory of control, we determined amplitude-phase function of the drill string by the effort, which it transmits to the well bottom. APF of the drill string for effort is defined by length of the column l_k , constant of damping time δ_1 , wave resistance z_{10} , proportionality coefficient k_n and largely depends on the degree of consistency between parameters of the column and parameters of the link “bit – rock”. It was established that amplitude-phase characteristic of the drill string changes with increasing depth of the well.

The problem is solved for drilling a well with immersed engines, when the drill string is not rotating. This makes it possible to resolve an applied task of choosing the structure of amplitude-phase function of the drill string depending on depth of the well and to apply it in the automated control system over the process of drilling a well.

2. In line with the theory of synergetic information we determined R -function as a generalized characteristic for relation between order and chaos. This allows us under online mode based on actual experimental data on drilling the wells to analyze dynamic modes of deepening a well and to determine their dynamic stability. We defined five modes of operation of the drilling process as a complex dynamic system: equilibrium, ordered, sorted-chaotic, randomly-ordered, chaotic. To describe determining of dynamic modes, the logic rules were synthesized. This makes it possible to apply intelligent technologies of control for solving the problem of optimization of the drilling process. Such technologies are based on the energoinformational approach and combine two effective methods of modern theory of control – adaptive and robust.

References

1. Ohorodnikov P. I., Svitlytskyi V. M., Hohol V. I. Doslidzhennia zviyazku mizh pozdovzhnimy i krutynymy kolyvanniamy burylnoi kolony // Naftohazova haluz Ukrainy. 2014. Issue 2. P. 6–10.
2. Svitlytskyi V. M., Hohol V. I. Analiz vibratsiynoi mitsnosti burylnoi kolony // Materialy 9-oi mizhnarodnoi naukovo-praktychnoi konferentsii «Nafta i haz Ukrainy – 2013». Yaremne, 2013. P. 65–66.
3. Gulyaev V. I., Gaidachuk V. V., Glushakova O. V. Andronov-Hopf bifurcations in wave models of torsional vibrational of drill strings // International Applied Mechanics. 2011. Vol. 46, Issue 11. P. 1275–1283. doi: 10.1007/s10778-011-0420-y
4. Hakimi H., Moradi S. Drillstring vibration analysis using differential quadrature method // Journal of Petroleum Science and Engineering. 2010. Vol. 70, Issue 3-4. P. 235–242. doi: 10.1016/j.petrol.2009.11.016
5. Nandakumar K., Wiercigroch M. Stability analysis of a state dependent delayed, coupled two DOF model of drill-string vibration // Journal of Sound and Vibration. 2013. Vol. 332, Issue 10. P. 2575–2592. doi: 10.1016/j.jsv.2012.12.020

6. Gulyayev V. I., Borshch O. I. Free vibrations of drill strings in hyper deep vertical bore-wells // *Journal of Petroleum Science and Engineering*. 2011. Vol. 78. P. 759–764. doi: 10.1016/j.petrol.2011.09.001
7. Simulation of Movement of Drill Rods at Large Deformation / Krajiyeva L. A., Kydyrbekuly A. B., Sergaliev A., Umbetkulova A. // *Advanced Materials Research*. 2013. Vol. 702. P. 253–258. doi: 10.4028/www.scientific.net/amr.702.253
8. Parepa S., Nicolae I. Experimental researches regarding the drilling process of the mine shafts by means of surface installations // *Annual of the university of mining and geology “St. Ivan Rilski”*. 2005. Vol. 48. P. 47–52.
9. Application of Computer Programming to Estimate Volumetric Change of an Active Drilling Fluid System Cause by Elastic Deformation of an Open Borehole Section Wall / Elmgerbi A., Thonhauser G. et. al. // *Global Journal of Computer Science and Technology*. 2016. Vol. 16, Issue 3. P. 14–29.
10. Ohorodnikov P. I., Svitlytskyi V. M., Hohol V. I. Deiaki pytannia ekspluatatsiynoi nadiynosti burylnoi kolony ta yii elementiv u protsesi budivnytstva sverdlovyny // *Naftohazova haluz Ukrainy*. 2013. Issue 1. P. 9–14.
11. Umbetkulova A. B. Modeling of drill string nonlinear longitudinal-transverse vibrations and their analysis // *Bulletin of National Academy of Sciences of the Republic of Kazakhstan*. 2017. Vol. 1, Issue 365. P. 255–265.
12. Parepa S. Experimental researches regarding the dynamics of the mine shafts drilling process // „Universitaria ROPET 2001” International Symposium. Vol. 1. Mining engineering. University of Petroșani, 2001. P. 105–108.
13. Rappold K. Drill string vibration measurements detect bit stick-slip // *Oil and Gas Journal*. 1993. P. 66–70.
14. Carcione J. M., Poletto F. A telegrapher equation for electric – telemetering in drill strings // *IEEE Transactions on Geoscience and Remote Sensing*. 2002. Vol. 40, Issue 5. P. 1047–1053. doi: 10.1109/tgrs.2002.1010892
15. Che D., Ehmann K., Cao J. Analytical Modeling of Heat Transfer in Polycrystalline Diamond Compact Cutters in Rock Turning Processes // *Journal of Manufacturing Science and Engineering*. 2015. Vol. 137, Issue 3. P. 031005. doi: 10.1115/1.4029653
16. PDC Bit Technology for the 21st Century / Bruton G., Crockett R., Taylor M. et. al. // *Oilfield Review*. 2014. Vol. 26, Issue 2. P. 48–57.
17. Chen Y., Liu Z. Y., Duan L. C. Simulation on Hydraulic Performance of Two Kinds of Coring Diamond Bits with Different Crown // *Advanced Materials Research*. 2012. Vol. 497. P. 350–355. doi: 10.4028/www.scientific.net/amr.497.350
18. Drilling characteristics of combinations of different high pressure jet nozzles / Zhang, Y., Liu, Y., Xu, Y., Ren, J. // *Journal of Hydrodynamics, Ser. B*. 2011. Vol. 23, Issue 3. P. 384–390. doi: 10.1016/s1001-6058(10)60127-8
19. Yang X., Li X., Lu Y. Temperature analysis of drill bit in rock drilling // *Journal of Central South University (Science and Technology)*. 2011. Vol. 10. P. 46–56.
20. Development of Downhole Motor Drilling Test Platform / Mingxin H., Yu, W., Baolin L., Mingshuai G., Liguang W. // *Procedia Engineering*. 2014. Vol. 73. P. 71–77. doi: 10.1016/j.proeng.2014.06.172
21. Fernandez M., Ibanez D., Storey D. Significant Results in Field Trials (Argentina) of an Electronically Controlled Automatic Drilling System // *Proceedings of SPE Latin American and Caribbean Petroleum Engineering Conference*. 2005. doi: 10.2523/94889-ms
22. Design Considerations and Field Performance of an Advanced Automatic Driller / Boyadjieff G., Murray D., Orr A., Porche M., Thompson P. // *SPE/IADC Drilling Conference*. 2003. doi: 10.2118/79827-ms
23. Real-time Well Construction Monitoring – A Case History of Sincor’s Heavy Oil Project / Branch A. J., Andersen K., Lavillonniere J. L., Larsen T., Kremer Y., Capacho G. A. // *Proceedings of SPE/IADC Drilling Conference*. 2001. doi: 10.2523/67757-ms
24. Ohorodnikov P. I., Svitlytskyi V. M., Hohol V. I. Analiz vibratsiynoi mitsnosti burylnoi kolony z vykorystanniam teoriiy vypadkovykh kolyvan // *Naftohazova haluz Ukrainy*. 2013. Issue 2. P. 13–18.
25. Real-Time Data Analysis While Drilling Provides Risk Management for Both Geological and Geometric Uncertainties in the Sotong K2.0 Reservoir / Md Zin Che L., Sering L., Bakar A. A., Sundal E., Daudey J. // *SPE Asia Pacific Oil and Gas Conference and Exhibition*. 2000. doi: 10.2118/64477-ms
26. Vyatkin V. B. Sinergeticheskaya teoriya informatsii. Ch. 2. Otrazhenie diskretnykh sistem v ploskosti priznakov ih opisaniya // *Nauchnyy zhurnal KubTAU*. 2009. Issue 45.
27. Oganov G. S., Shirin-Zade S. A., Paramonov A. A. Dinamicheskyy analiz protsessa uglubleniya skvazhin // *Vestnik Assotsiatsii burovyyh podryadnikov*. 2009. Issue 1. P. 40–44.