

*Die casting is forcing molten metal into a mould with high pressure. Die casting has two dies namely moving die and fixed die where the moving one will move over the fixed die. Die casting is majorly used for high-volume production. This paper focused on the physical phenomenon of die casting for two dies (moving die and fixed die) using two different alloy materials with variable material chemical compositions.*

*The numerical analysis is carried out for the die casting process to determine the crack formation zone by temperature distribution and structural analysis by stress-strain relationship. The numerical analysis is carried out for both the dies. The fixed die is analyzed with an H13 tool steel material with two moving die materials as aluminum alloy (A356) and magnesium alloy (AZ91D). Both the dies (fixed and moving) were designed by using design software and meshing is carried out followed by analysis using the analysis software. The physical parameter for the dies is applied that is temperature distribution is carried out by applying a temperature of 850 °C and 650 °C over the fixed die for aluminum and magnesium alloy, respectively. Structural analysis is carried out for the moving die with a load of 1,000 N for both aluminum and magnesium alloys with 1000 number of iterations. The results from the numerical analysis are derived and analyzed for both temperature distribution and structural analysis. The crack formation zone is found out by means of temperature gradient and the stress-strain relationship is found out by means of structural analysis. From the results, it was concluded that the crack zone is obtained at  $1.22E-10$  °C/mm and  $6.856E-14$  °C/mm of thermal gradient and structural analysis in terms of maximum stress of 446.94 MPa and 448.52 MPa for aluminum and magnesium alloys, respectively*

*Keywords: Die casting, Aluminum, Magnesium, Crack analysis, Temperature distribution, Thermal gradient*

# NUMERICAL INVESTIGATION ON CRACK ANALYSIS OF H13 FIXED DIE AND STRUCTURAL ANALYSIS OF MOVING DIE WITH TWO DIFFERENT MATERIALS

Hassan Abdurssoul  
Abdulhadi

Department of Mechanical Techniques  
Institute of Technology Baghdad  
Middle Technical University  
Alzafaranya, Baghdad, Iraq, 10074  
E-mail: h.shamary@mtu.edu.iq

Received date 22.06.2021

Accepted date 10.11.2021

Published date 29.12.2021

**How to Cite:** Abdulhadi, H. A. (2021). Numerical investigation on crack analysis of H13 fixed die and structural analysis of moving die with two different materials. *Eastern-European Journal of Enterprise Technologies*, 6 (1 (114)), 81–86. doi: <https://doi.org/10.15587/1729-4061.2021.244876>

## 1. Introduction

Molten metals are formed with the application of high pressure into a mould cavity, in which the mould cavity is fabricated by two hardened tool steel dies, by the process of machining, the mould cavity is shaped depending on the application. Mostly, non-ferrous metals are used for die-casting and depends upon the type of metal being used, a machine such as hot or cold chamber is used. For high-volume production, die casting is widely used. This paper investigates the physical phenomenon of die casting for two dies (moving die and fixed die) using two different alloy materials in which chemical composition variance is also explained in the material. From the numerical analysis, it can be explained about the weak region and strong region for both temperature distribution and crack formation and also the life span of dies depends on the number of cycles used, materials used and temperature used to be determined.

AISI H13 and AISI H11 are used to find out the resistance capacity towards thermal fatigue over the surface layer, which the surface is cladded by GTA welding. Thermal fatigue resistance is experimented by the continuous cycle of heating and cooling in the bath of aluminum alloy 226 and water-based lubricant, respectively. The results indicate that fatigue resistance of maraging steel weld is lower than the AISI H11 tools [1]. The mass of automotive can be decreased

by using magnesium-based die casting because magnesium die casting has the advantage of near net shape forming, light weight, optimized strength to weight ratio, consolidation of part and additional components integration [2].

## 2. Literature review and problem statement

Analysis of the insert is carried out in the die casting tool, for carrying of AlSi9Cu3Fe. The numerical and experimental analysis is carried out for the insert in which numerical analysis is carried out by a new procedure, which combines MAGMA and CalculiX and during experimental analysis, hardness measurements, light microscopy, SEM analysis and XRD pattern are obtained in order to examine the insertion in the die casting process of AlSi9Cu3Fe [3]. Machine learning and numerical simulation are carried out to optimize the solidification in die casting that is product quality by obtaining initial and wall temperatures. NSGA II algorithm is carried out to optimize multiobjective optimization, which function evaluation of NSGA II is performed over the order of millions. Due to this, a finite volume solver can't be used for the optimization process [4].

AZ91 magnesium alloy is investigated experimentally for the parametrical effects of cold chamber die casting with high speed drilling machinability. Parameters such as

machinability properties, microstructure properties and mechanical properties are examined and the results showed that the grain size varies depending on the pressure, temperature and speed of the gate [5]. Investigation on aluminum bilayer billets was carried out by considering the influencing parameters such as cooling condition and die temperature on the formation of the interface. The investigation is carried out for the chain of casting and massive forming between interface evolutions [6].

MAGMASOFT software is used for numerical investigation in order to detect certain defects such as issues in riser level, solidification, which leads to shrinkage and imperfections in the mould cavity, which helps to improvise the process of casting in aluminum based alloys by the method of gravity. The results concluded that changing design helps to improve the defects in the centrifugal pump crank case [7]. High-pressure die casting is investigated for AL-10 wt % Si alloy by using a scanning electron microscope, computed tomography (CT) and optical microscope (OM). The investigation is carried out to define the relationship between the microstructure and fraction of high-pressure die casting (Al-10 wt % Si) alloy [8]. AlSi12Fe alloy die casting is manufactured by the process of vacuum-assisted high-pressure die casting. Under various vacuum levels and investigation is carried out for certain parameters such as mechanical property, porosity and thermal conductivity. From investigation, as vacuum levels increase, yield strength improves and average porosity reduces [9]. An examination was done on prematurely failed pins used in die-casting dies for aluminum engine blocks. To research the reasons for the failures, static and fatigue strength evaluations of the pin materials and the deterioration degree of the strength because of exposure to high temperatures were assessed. The greatest thermal stresses were utilized to anticipate the fatigue lifetime of the pin. The consequence of this examination uncovers that cooling holes at the center point of the pin were machined with some level of unusualness, prompting a centralization of the thermal stress on the thin part and, at last bringing about a premature failure. Proper machining of a cooling opening in the pass on pins should be completed to keep away from premature failure of these parts [10].

From the review analysis, the die material characteristics behavior has a major influence on the life span of dies. The main parameters that affect the lifespan of dies are thermal characteristics and structural characteristics. As per the literature review, temperature characteristics directly depend on various failure modes of dies. So, this paper influences the temperature distribution and structural analysis of dies with different materials to determine the crack formation with their respective iterations, which directly influence the life span of the die material.

### 3. The aim and objectives of the study

The aim of the study is to find out the temperature distribution of both moving and fixed die in which the crack formation can be found out by means of temperature distribution with the help of numerical analysis over a number of iterations.

To achieve the aim, the following objectives are accomplished:

- to design and fabricate the fixed and moving die with two different alloy materials;

- to derive the temperature distribution of die casting over the number of cycles to enumerate crack analysis of the fixed die;

- to find out the crack formation zone or weak zone to its respective number of iterations for two different alloys to define structural analysis of the moving die;

- to define structural analysis of the ingot and to validate the material performance for crack formation by means of temperature distribution between two different alloys.

## 4. Materials and methods

### 4.1. Materials

Materials used for the die casting process are discussed in the following section. There are two dies namely fixed and moving die. For the fixed die, H13 material is used, and for the moving die, two different alloys are used such as magnesium alloy (AZ91D) and aluminum alloy (A356). The chemical composition of the moving die material such as AZ91D and A356 is given in Table 1.

Table 1

Chemical composition of alloys

S. No	Composition	Magnesium Alloy (%)	Aluminum Alloy (%)
1	Aluminum	88.51	92.05
2	Magnesium	8.1	0.35
3	Silicon	0.20	7
4	Iron	0.0050	0.20
5	Copper	0.0015	0.20
6	Manganese	0.17	0.10
7	Zinc	0.40	0.10

H13 is a tool steel widely used in hot and cold work tooling applications due to its great stability towards heat treatment. The thermal conductivity of H13 at a temperature range of 800 °C is 25.1 W/m °C and its toughness is also high. The re-melting process of H13 material enhances the homogeneity of the chemical composition and also enhances the mechanical properties. Magnesium alloy (AZ91D) and aluminum alloy (A356) are used as moving die materials for analysis and their chemical composition is given in Table 1. These two alloys are widely used in aerospace industries.

### 4.2. 3D Design

Dies used for the die casting process are designed and their respective dimensional design is given in Fig. 1 below.

The design of the fixed die shown in Fig. 1 based on the dimension given is developed using design software and taken for analysis. All the dimensions are given in mm.

### 4.3. Mesh

Mesh is the pre-processing process of analysis, in which it has three types namely coarse, medium and fine mesh. For crack analysis, mesh is carried out for the fixed die with medium mesh shown in Fig. 2 and for structural analysis; mesh is carried out for the moving die with fine mesh shown in Fig. 3. The selection of medium and fine mesh is mainly based on the computational time taken for each analysis and results obtained.

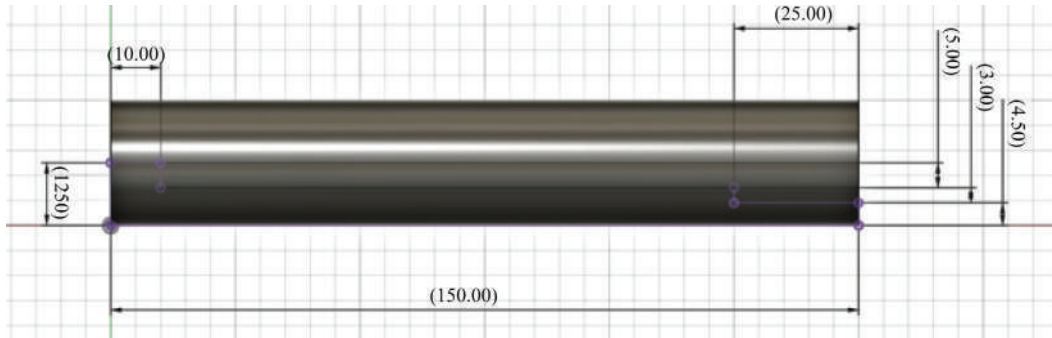

Fig. 1. 3D dimensional design of the fixed die

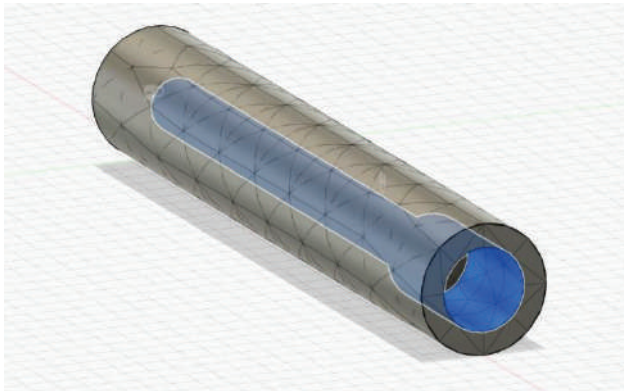

Fig. 2. Mesh image of the fixed die

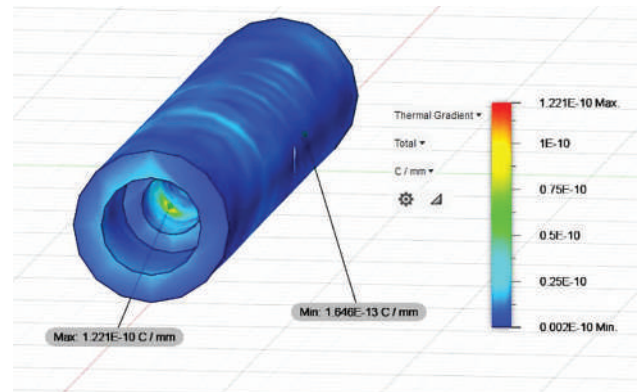

Fig. 4. Temperature distribution of aluminum alloy

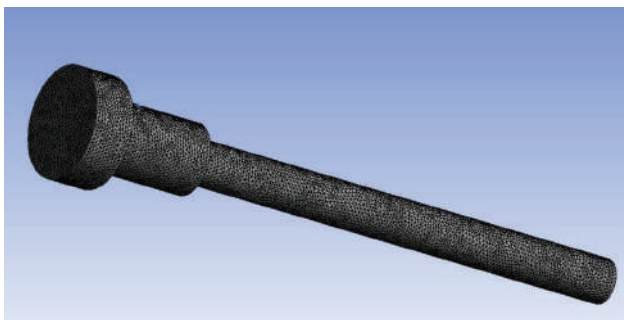

Fig. 3. Mesh image of the moving die

Fig. 2 explains the mesh image of the fixed die on which analysis is carried out. Mesh used in the fixed die is medium mesh because of its computational time and Fig. 3 explains about the mesh image of the moving die on which analysis is carried out. Fine mesh is used for the moving die with 7,533 number of elements.

## 5. Results of numerical analysis of the fixed and moving die

### 5. 1. Crack analysis of the fixed die

Fixed die made of H13 tool steel is analyzed for temperature distribution in order to find out the crack formation zone in the die. The physical condition that is thermal gradient is given in the inner surface of the fixed die for both alloys such as aluminum alloy (A356) and magnesium alloy (AZ91D). Fig. 4 explains the temperature distribution of aluminum alloy and Fig. 5 explains the temperature distribution of magnesium alloy.

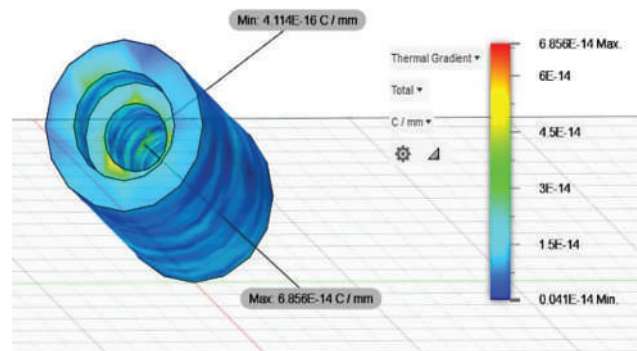

Fig. 5. Temperature distribution of magnesium alloy

The analysis is carried out to determine the crack formation zone for magnesium alloy by applying a temperature of 650 °C on the surface of the fixed die. From the analysis, the temperature gradient is determined with a maximum of 6.856E-14 °C/mm and a minimum of 4.114E-16 °C/mm. From the results, the crack zone is determined as the zone with

the maximum temperature gradient of  $6.856E-14$  °C/mm for the magnesium alloy-based fixed die.

**5. 2. Structural analysis of the moving die**

The structural analysis is carried out for the moving die in order to determine the amount of stress and strain generated in the moving die for two alloys namely magnesium alloy (AZ91D) and aluminum alloy (A356). Analysis is carried out and the stress-strain relationship is determined with force convergence data. The force convergence with the number of iterations is analyzed and the stress-strain graph is obtained by applying the load of 1,000N with maximum time steps of 1,000.

**5. 3. Structural analysis of the ingot**

From Fig. 6, at the iteration rate of 502, aluminum alloy material starts elongation with a force of  $1.8e-5$  N and the force convergence curve represents the elongation of aluminum alloy in which all 502 iterations are achieved by 1 sec. The stress-strain graph is obtained shown in Fig. 7. It shows

that breaking of the aluminum alloy-based moving die occurs at the maximum stress of 446.94 MPa with a linear deviation of strain  $6.324e-3$  mm/mm. As the stress of the aluminum alloy-based moving die is increasing, strain is also linearly increasing in which at a point of 446.94 MPa stress, the material begins to develop a crack in the moving die for aluminum alloy.

The force convergence with respect to iterations for magnesium alloy is shown in Fig. 8 in which magnesium alloy material starts elongation with a force of  $3.1e-5$  N and the force convergence curve represents the elongation of magnesium alloy in which all 502 iterations are achieved by 1 sec. The stress-strain graph is obtained shown in Fig. 9.

It is shown that breaking of the magnesium alloy-based moving die occurs at the maximum stress of 448.52 MPa with a linear deviation of strain  $1.0013e-2$  mm/mm. As the stress of the magnesium alloy-based moving die is increasing, strain is also linearly increasing in which at a point of 448.52 MPa stress, the material begins to develop a crack in the moving die for aluminum alloy.

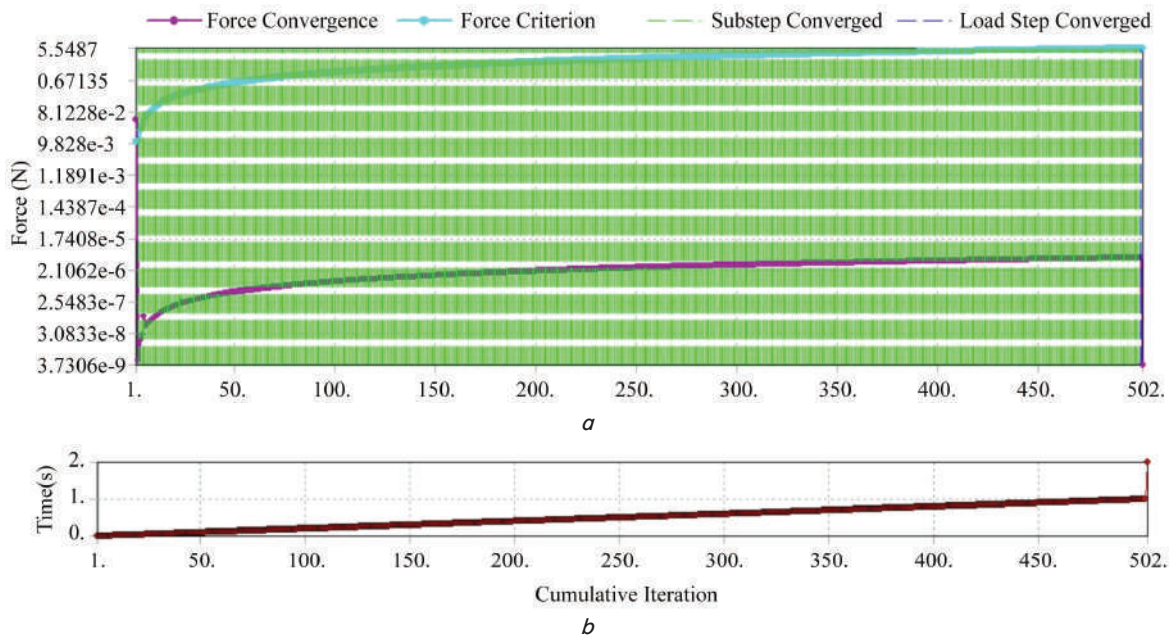

Fig. 6. Structural analysis of: a – convergence of force; b – iteration for aluminum alloy

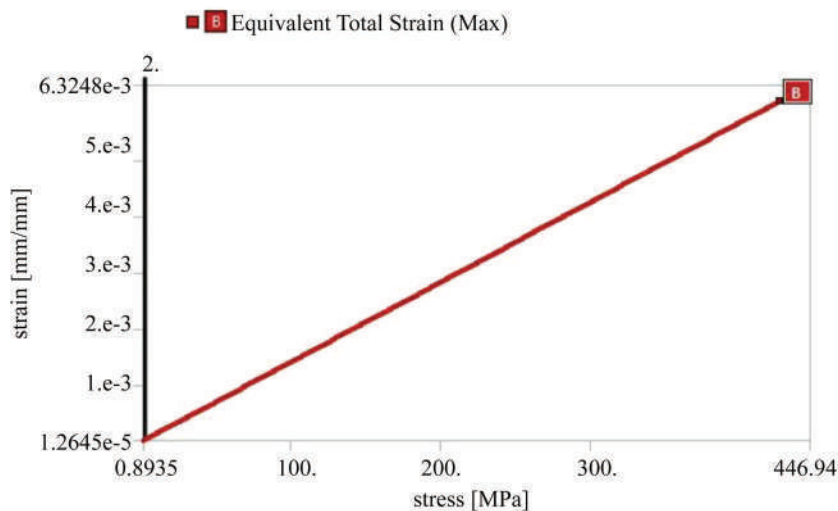

Fig. 7. Stress-strain relationship for aluminum alloy

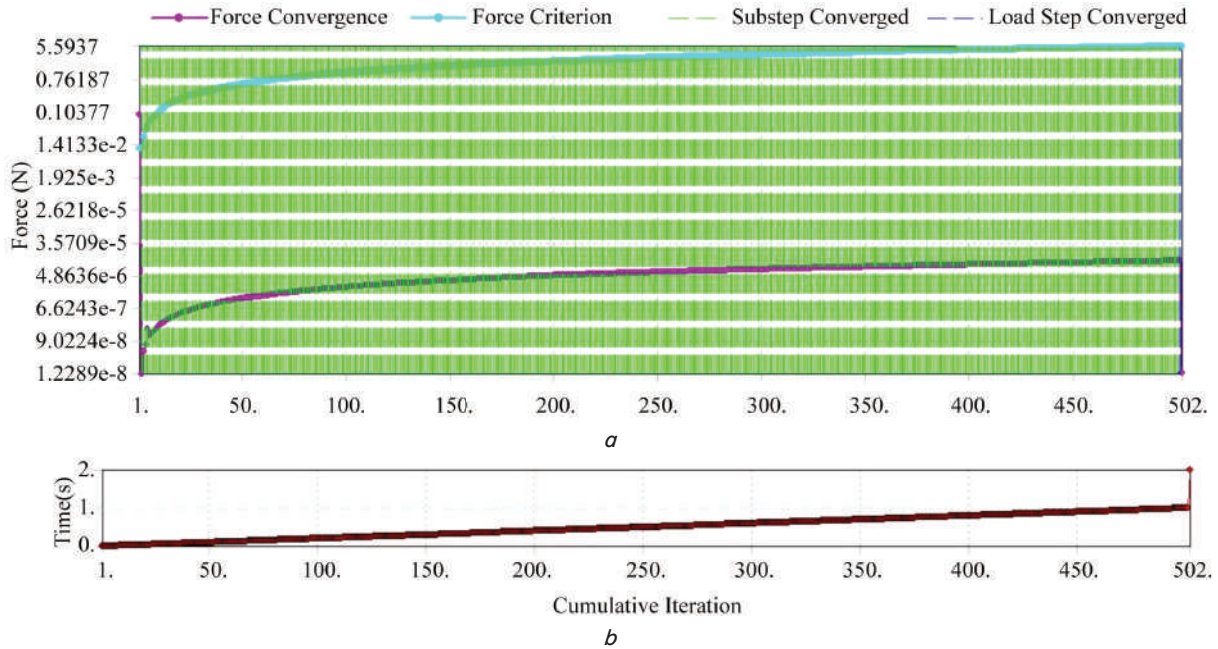

Fig. 8. Structural analysis of: *a* – convergence of force; *b* – iteration for magnesium alloy

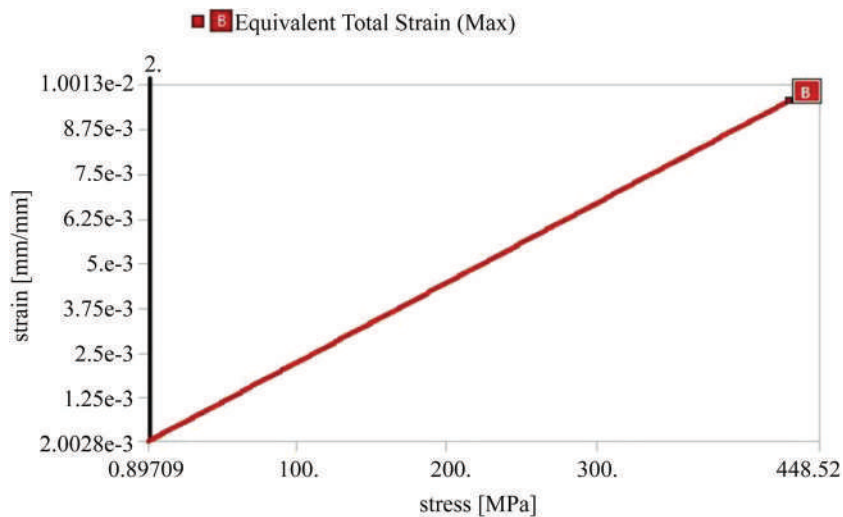

Fig. 9. Stress-strain relationship for magnesium alloy

## 6. Discussion of the research results of dies

The moving die made up of two different materials such as magnesium alloy (AZ91D) and aluminum alloy (A356) and the fixed die made up of H13 material are designed with their respective dimensions shown in Fig. 1. The numerical analysis is carried out in order to determine the crack formation zone by temperature distribution and structural analysis by stress-strain relationship.

The numerical analysis is carried out to determine the crack by means of temperature distribution as a thermal gradient. As pouring temperature of 850 °C, the maximum and minimum temperature gradient is 1.22E-10 °C/mm and 1.646E-13 °C/mm, the crack is formed in the zone of 1.22E-10 °C/mm for aluminum alloy shown in Fig. 4. Similarly for magnesium alloy, the maximum and minimum temperature gradient is 6.856E-14 °C/mm and 4.114E-16 °C/mm, the crack is formed in the zone of 6.856E-14 °C/mm for magnesium alloy shown in Fig. 5.

Structural analysis is carried out by applying 1,000 N load with maximum time steps of 1,000 for both aluminum and magnesium alloy. As per results, the cracing of aluminum alloy and magnesium alloy occurs at a maximum stress of 446.9 MPa and 448.52 MPa, respectively. Once the alloy material reaches its respective maximum stress value, the crack tends to develop with a linear deviation of strain 6.324E-3 mm/mm for aluminum and 1.0013E3 mm/mm for magnesium shown in Fig. 7, 9.

From the results, the crack zone for the aluminum alloy-based fixed die is found at the range of 1.22E-10 °C/mm thermal gradient and for magnesium alloy is at the range of 6.856E-14 °C/mm thermal gradient. From structural analysis, the moving die of aluminum alloy and magnesium alloy has a maximum stress of 446.94 MPa and 448.52 MPa with a linear relationship in strain of 6.324e-3 mm/mm and 1.0013e-2 mm/mm. Once materials achieved their respective maximum temperature gradient and maximum stress, cracking begins in the material. As the number of timestep increases beyond

its limit, the crack begins to expand, which leads to material failure. So, the application of these alloy materials in dies should be within the prescribed temperature gradient and maximum stress.

---

## 7. Conclusions

---

1. Moving die and fixed die were designed by using design software and analysis software, meshing is also carried out for both dies of the die casting process.

2. The temperature distribution was carried out in order to find the range of temperature over 1,000 number of iterations and the crack formation zone is also found out.

3. The crack zone for the aluminum alloy-based fixed die is found at the range of  $1.22E-10$  °C/mm thermal gradient and for magnesium alloy is at the range of  $6.856E-14$  °C/mm thermal gradient.

4. From structural analysis, the moving die of aluminum alloy and magnesium alloy has a maximum stress of 446.94 MPa and 448.52 MPa with a linear relationship in strain of  $6.324e-3$  mm/mm and  $1.0013e-2$  mm/mm.

---

## Acknowledgments

---

The author introduces his thanks to Middle Technical University Baghdad/Iraq to support this research paper.

---

## References

- Klobčar, D., Tušek, J., Taljat, B. (2008). Thermal fatigue of materials for die-casting tooling. *Materials Science and Engineering: A*, 472 (1-2), 198–207. doi: <https://doi.org/10.1016/j.msea.2007.03.025>
- Weiler, J. P. (2019). A review of magnesium die-castings for closure applications. *Journal of Magnesium and Alloys*, 7 (2), 297–304. doi: <https://doi.org/10.1016/j.jma.2019.02.005>
- Markežič, R., Naglič, I., Mole, N., Šturm, R. (2019). Experimental and numerical analysis of failures on a die insert for high pressure die casting. *Engineering Failure Analysis*, 95, 171–180. doi: <https://doi.org/10.1016/j.engfailanal.2018.09.010>
- Shahane, S., Aluru, N., Ferreira, P., Kapoor, S. G., Vanka, S. P. (2020). Optimization of solidification in die casting using numerical simulations and machine learning. *Journal of Manufacturing Processes*, 51, 130–141. doi: <https://doi.org/10.1016/j.jmapro.2020.01.016>
- Yazman, Ş., Köklü, U., Urtekin, L., Morkavuk, S., Gemi, L. (2020). Experimental study on the effects of cold chamber die casting parameters on high-speed drilling machinability of casted AZ91 alloy. *Journal of Manufacturing Processes*, 57, 136–152. doi: <https://doi.org/10.1016/j.jmapro.2020.05.050>
- Greß, T., Mittler, T., Chen, H., Stahl, J., Schmid, S., Ben Khalifa, N., Volk, W. (2020). Production of aluminum AA7075/6060 compounds by die casting and hot extrusion. *Journal of Materials Processing Technology*, 280, 116594. doi: <https://doi.org/10.1016/j.jmatprotec.2020.116594>
- Aravind, S., Ragupathi, P., Vignesh, G. (2021). Numerical and experimental approach to eliminate defects in Al alloy pump-crank case processed through gravity die casting route. *Materials Today: Proceedings*, 37, 1772–1777. doi: <https://doi.org/10.1016/j.matpr.2020.07.365>
- Jiao, X., Liu, C., Wang, J., Guo, Z., Wang, J., Wang, Z. et. al. (2020). On the characterization of microstructure and fracture in a high-pressure die-casting Al-10 wt%Si alloy. *Progress in Natural Science: Materials International*, 30 (2), 221–228. doi: <https://doi.org/10.1016/j.pnsc.2019.04.008>
- Hu, C., Zhao, H., Wang, X., Fu, J. (2020). Microstructure and properties of AlSi12Fe alloy high pressure die-castings under different vacuum levels. *Vacuum*, 180, 109561. doi: <https://doi.org/10.1016/j.vacuum.2020.109561>
- Kang, S.-H., Han, J.-J., Hwang, W.-T., Lee, S.-M., Kim, H.-K. (2019). Failure analysis of die casting pins for an aluminum engine block. *Engineering Failure Analysis*, 104, 690–703. doi: <https://doi.org/10.1016/j.engfailanal.2019.06.053>
- Liu, W., Peng, T., Tang, R., Umeda, Y., Hu, L. (2020). An Internet of Things-enabled model-based approach to improving the energy efficiency of aluminum die casting processes. *Energy*, 202, 117716. doi: <https://doi.org/10.1016/j.energy.2020.117716>
- Lordan, E., Lazaro-Nebreda, J., Zhang, Y., Dou, K., Blake, P., Fan, Z. (2020). On the relationship between internal porosity and the tensile ductility of aluminium alloy die-castings. *Materials Science and Engineering: A*, 778, 139107. doi: <https://doi.org/10.1016/j.msea.2020.139107>
- Xiong, S. M., Lau, F., Lee, W. B., Jia, L. R. (2003). Numerical methods to improve the computational efficiency of thermal analysis for the die casting process. *Journal of Materials Processing Technology*, 139 (1-3), 457–461. doi: [https://doi.org/10.1016/s0924-0136\(03\)00553-3](https://doi.org/10.1016/s0924-0136(03)00553-3)
- Zhao, H. D., Wang, F., Li, Y. Y., Xia, W. (2009). Experimental and numerical analysis of gas entrapment defects in plate ADC12 die castings. *Journal of Materials Processing Technology*, 209 (9), 4537–4542. doi: <https://doi.org/10.1016/j.jmatprotec.2008.10.028>
- Srivastava, A., Joshi, V., Shivpuri, R. (2004). Computer modeling and prediction of thermal fatigue cracking in die-casting tooling. *Wear*, 256 (1-2), 38–43. doi: [https://doi.org/10.1016/s0043-1648\(03\)00281-3](https://doi.org/10.1016/s0043-1648(03)00281-3)