

Non-contact photoplethysmographic sensors for monitoring students' cardiovascular system functional state in an IoT system

Tetiana M. Nikitchuk¹, Tetiana A. Vakaliuk^{1,2,3}, Oksana A. Chernysh¹,
Oksana L. Korenivska¹, Liudmyla A. Martseva¹ and Viacheslav V. Osadchyi^{4,5}

¹Zhytomyr Polytechnic State University, 103 Chudnivsyka Str., Zhytomyr, 10005, Ukraine

²Institute for Digitalisation of Education of the NAES of Ukraine, 9 M. Berlynskoho Str., Kyiv, 04060, Ukraine

³Kryvyi Rih State Pedagogical University, 54 Gagarin Ave., Kryvyi Rih, 50086, Ukraine

⁴Borys Grinchenko Kyiv University, 18/2 Bulvarno-Kudriavska Str., Kyiv, 04053, Ukraine

⁵Academy of Cognitive and Natural Sciences, 54 Gagarin Ave., Kryvyi Rih, 50086, Ukraine

Abstract. This article explores the technical feasibility of a hardware complex that employs photoplethysmographic sensors to measure the parameters of students' cardiovascular system functional state. The method of photoplethysmography utilizes non-contact sensors, which eliminate circulatory disorders caused by artery compression and enable the calculation of oxygen saturation via the pulse wave. The proposed hardware consists of several optocouplers arranged in series, parallel, or parallel-series configurations, with the mode of operation controlled by the intensity of the received pulse wave signal, depending on the individual's body constitution. The edge device hardware is a component of an Internet of Things (IoT) system that includes another edge device, which instantaneously transmits data to a database on the edge server for further processing and storage.

Keywords: photoplethysmography, IoT, cardiovascular system, non-contact sensors, edge computing, data processing

1. Introduction

2020 is the year of the COVID-19 pandemic [31], which forced people to change their attitude to health. In the period of morbidity, when the number of the infected is constantly increasing exponentially (figure 1), early detection of certain abnormalities in health is a precautionary

✉ tnikitchuk@ukr.net (T. M. Nikitchuk); tetianavakaliuk@gmail.com (T. A. Vakaliuk); chernyshoxana@gmail.com (O. A. Chernysh); o.l.korenivska@gmail.com (Oksana L. Korenivska); l.a.martseva@gmail.com (L. A. Martseva); poliform55@gmail.com (V. V. Osadchyi)

🌐 <https://ztu.edu.ua/ua/structure/faculties/fikt/krt.php> (T. M. Nikitchuk);

<https://sites.google.com/view/neota/profile-vakaliuk-t> (T. A. Vakaliuk); <https://ztu.edu.ua/ua/structure/pv/>

(O. A. Chernysh); https://ztu.edu.ua/ua/structure/faculties/fikt/teachers_krt.php (Oksana L. Korenivska);

https://ztu.edu.ua/ua/structure/faculties/fikt/teachers_kikm.php (L. A. Martseva);

<https://kubg.edu.ua/prouniversitet/vizytivka/rektorat/dyrektory/1175-osadchyi-viacheslav-volodymyrovych.html> (V. V. Osadchyi)

🆔 0000-0002-9068-931X (T. M. Nikitchuk); 0000-0001-6825-4697 (T. A. Vakaliuk); 0000-0002-2010-200X

(O. A. Chernysh); 0000-0002-3735-7690 (Oksana L. Korenivska); 0000-0001-5037-6565 (L. A. Martseva);

0000-0001-5659-4774 (V. V. Osadchyi)



© Copyright for this paper by its authors, published by Academy of Cognitive and Natural Sciences (ACNS). This is an Open Access article distributed under the terms of the Creative Commons License Attribution 4.0 International (CC BY 4.0), which permits unrestricted use, distribution, and reproduction in any medium, provided the original work is properly cited.

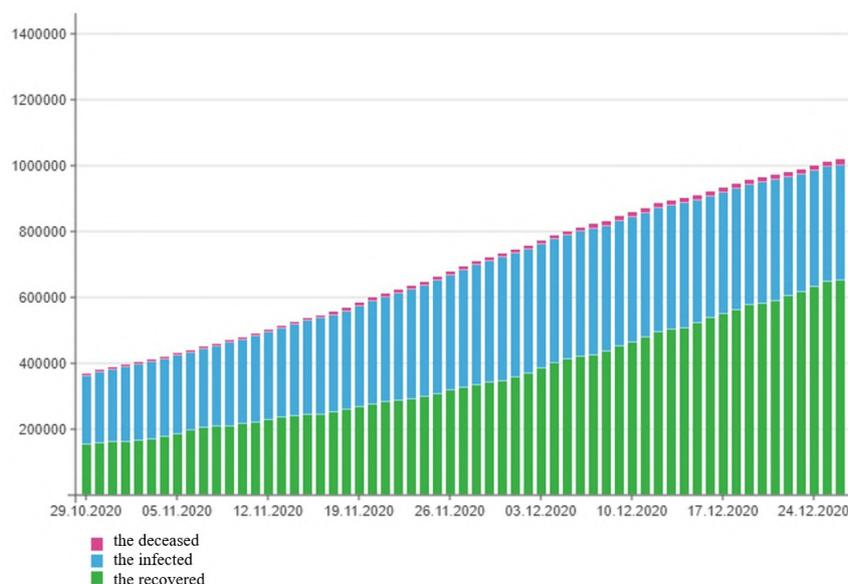

Figure 1: The number of people infected with COVID-19 at the end of 2020.

measure.

One of the requirements to participate in any event as well as attend classes is a satisfactory health condition. Therefore, in an educational institution, the problem of determining students' state of health arises.

Due to the COVID-19 outbreak, it has become impossible to monitor the health condition of a student body. Therefore, it is proposed to develop edge devices, the components of which will be partially located in classrooms.

The system screens and monitors the functional parameters of students' cardiovascular system and other organs for coronavirus symptoms, pre-existing and health condition. It displays the result on the edge device screen, or transfers it server, or a mobile device.

In the last decades of the last century – at the beginning of the current for the functional diagnosis of the cardiovascular and respiratory systems and, to some extent, the functional features of the circulatory system, pulse oximeters have become widespread. These are devices designed to determine the relative saturation of blood hemoglobin with oxygen in the natural conditions of human life and the dynamics of its performance of various functional tests [9, 22, 29].

In the middle – the last quarter of the 20th century photooxyhemographs were widely used to solve the problem mentioned above. Modern integrated pulse oximeters, in contrast, allow obtaining high-quality curves of peripheral arterial pulse due to periodic heart activity – photoplethysmograms (PPG) [9, 24].

The contour and form of photoplethysmograms greatly resembles the peripheral pulse curve (sphygmogram) obtained with mechanical pressure sensors that convert the oscillations of the wall of the pulsating artery into an electrical signal [9, 22, 24]. Therefore, pulse oximetry can be used as a source of primary biological information about heart rate and natural heart rate

variability [24].

Edge devices are viewed as a complex automated system [30]. It combines memory hardware (considered in the paper), data transmission and visualization unit, and the database. The database contains students' medical records, medical check-up data, and the data of patients' health condition monitoring.

1.1. Theoretical background

Prior researches prove that the introduction of ICT in the field of health care greatly contributes to health promotion and maintenance [5, 13–15, 20, 26, 27, 32]. Moreover, it improves the demographic situation, upgrades the quality and efficiency of health care. Furthermore, it ensures the human rights to health care [15]. Kachmar and Avramenko [10], Kachmar and Khvyshchun [11], Kopnyak [15] have made a significant scientific and practical contribution to the introduction of modern information technologies in the educational process as well as in health care institutions work in Ukraine.

A closer look to the literature on medical field informatization, however, reveals a number of gaps and shortcomings. Although there are many studies, the research in the assessment of medical information systems effectiveness remains limited. Nonetheless, there exists a considerable body of literature on organizational and economic efficiency of industrial, corporate, accounting and other types of information systems introduction in large enterprises, government agencies, and in the tourism industry [6, 12, 15, 19, 34, 36].

The study addresses several further questions on edge computing, which is a comparatively new area of research [18]. However, it has been successfully established and described by Hassan et al. [7]. The scientists bring some information about the role of edge computing in the internet of things [7]. They propose a layered model for the delivery of IoT services based on CloudEdge, as well as the taxonomy of the Edge Environment based on IoT (see figure 2). Moreover, the researchers provide a clear illustration of cloud computing complementary role in the IoT environment (see figure 3) [7].

A more comprehensive description can be found in the work of Candanedo and Corchado [3]. The scientists consider the concept of Edge Computing, and the possibility of Edge Computing integration. They suggest that it significantly contributes to optimizing the processes that are usually performed in a cloud computing environment [3]. In addition, the scientists successfully establish the relation between Edge and Cloud Computing (figure 4) [3].

Huh and Seo [8] present the framework, preconditions and discuss the advantages and disadvantages of edge calculations. The researchers describe how they function and provide their structure hierarchically with the concepts of artificial intelligence. Moreover, the scientists draw a comparison of the cloud and edge computing paradigm; propose a three-tier edge computing architecture, and develop the design of an edge computing environment with AI support (see figure 5).

The aim of this research is to develop the hardware of edge devices of pulse rapid diagnostics of human body functional state. Its parameters enable to identify the early symptoms of COVID-19 and determine the functional state of cardiovascular system. The hardware serves as a means of determining the parameters of human body functional state and can be installed in the places of student' study.

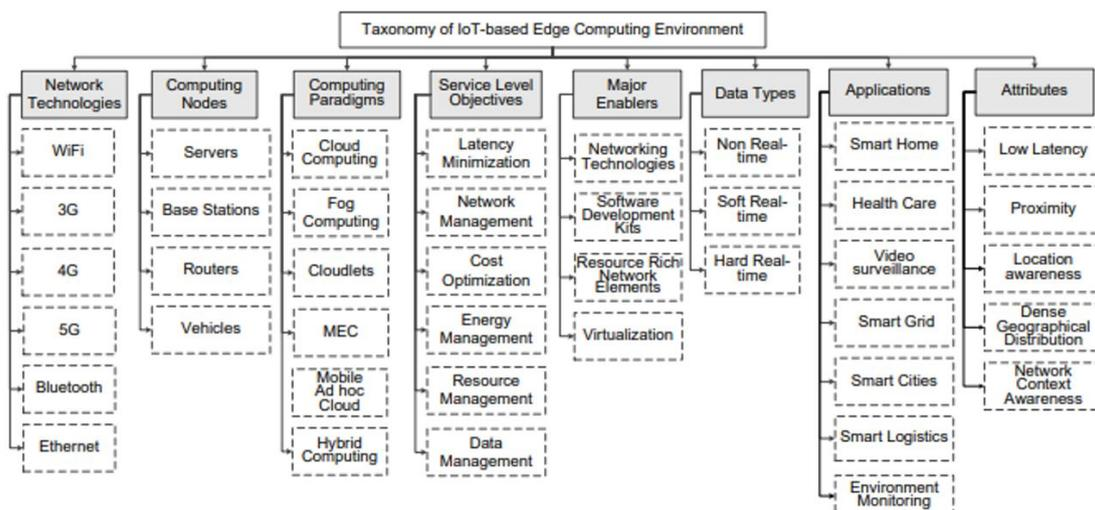

Figure 2: Taxonomy of IoT-based edge environment [7].

2. Results

The hardware complex is located in the classrooms and consists of 2 units:

1. the unit for determining students' health condition according to 4 parameters:
 - body temperature
 - saturation (oxygen saturation) of blood
 - heart rate (HR)
 - rapid diagnostics of cardiovascular system functional state
2. indoor air quality monitoring unit.

The article reviews the possibility of technical realization of hardware complex. It presupposes the use of sensors of registration of a photoplethysmographic curve, which describes a pulse wave and defines the parameters of students' cardiovascular system functional state.

The method of photoplethysmography is designed to study the cardiovascular system of biological objects in which the measurement of characteristics and parameters of blood circulation (pulse curve, blood pressure, arterial oxygen saturation level, etc.), vascular reactions and metabolic processes are performed by recording the fluxes intensity of electromagnetic radiation in the optical range (from visible – $0.4 \mu\text{m}$ to near-infrared – $1.5 \mu\text{m}$) after their interaction with the tissues of a living organism [1].

There are two types of photoplethysmographic methods: transmitted-light photoplethysmography and side-scattered photoplethysmography (figure 6).

The on the lumen method allows to install the sensor on a finger or an earlobe, as the radiating unit should fully X-ray the area. Moreover, the receiver, which is located perpendicularly, captures the light quantity that has passed through the finger. The on the reflection method presupposes that the light quantity from the radiating unit falls on a certain part of the body. In

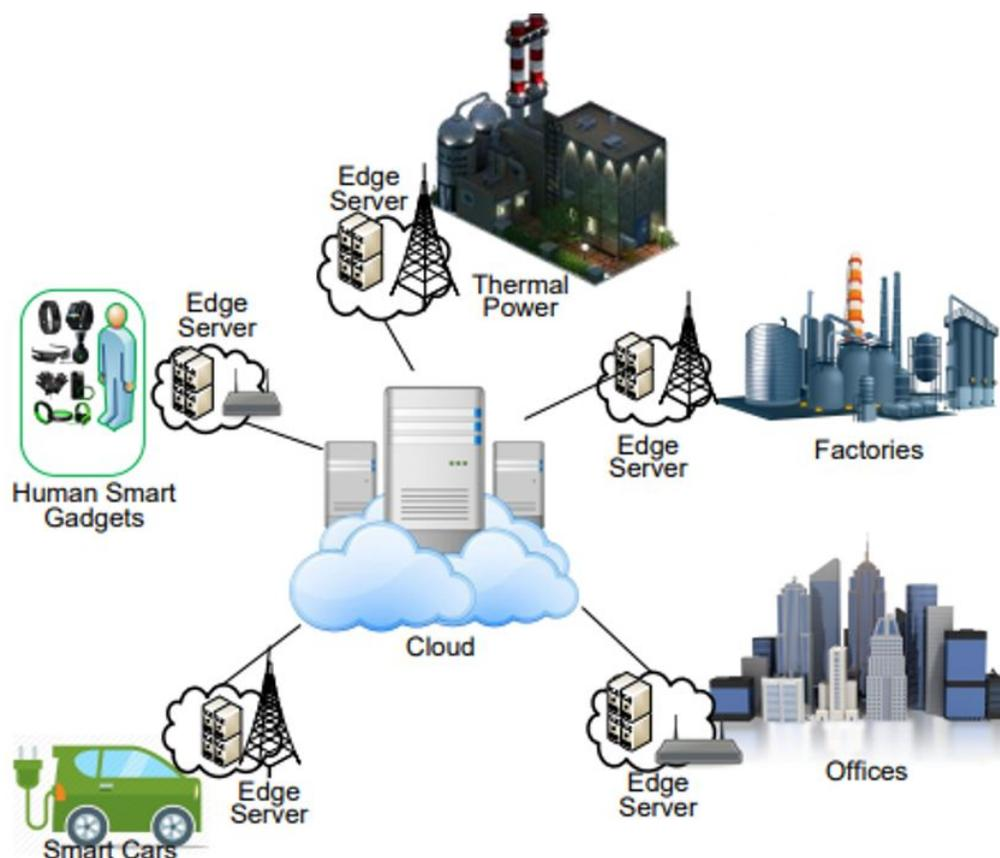

Figure 3: Illustration of edge cloud computing complimentary role in IoT environment [7].

such a case, some of the light is absorbed, and some is reflected and enters the code receiver. This method is more universal, as it is possible to place the sensor on any part of the body, if full contact with him is provided [1, 28, 33].

The basis of photopulse oximetry method lies in the measurement of light absorption of a certain wavelength by blood hemoglobin. Hemoglobin serves as a filter, what is more, the “color” and “thickness” of this natural filter can vary [28, 33]. The “color” of the filter depends on the percentage of oxyhemoglobin. That is how pulse oximetry determines the level of blood oxygenation.

Changes in the “thickness” of the filter are affected by the pulsation of the arterioles: each pulse wave increases the amount of blood in the arteries and arterioles. The doctor defines this as a pulse rate, and the pulse oximeter considers that as a “thickening” of the filter. In such a way, the pulse rate and amplitude of the pulse wave are measured.

Therefore, the use of one measurement principle allows determining three diagnostic parameters: the levels of saturation of hemoglobin with oxygen, the pulse rate and its “volume” amplitude. In addition, it enables further processing and analysis of pulse waves to determine the functional state of cardiovascular system.

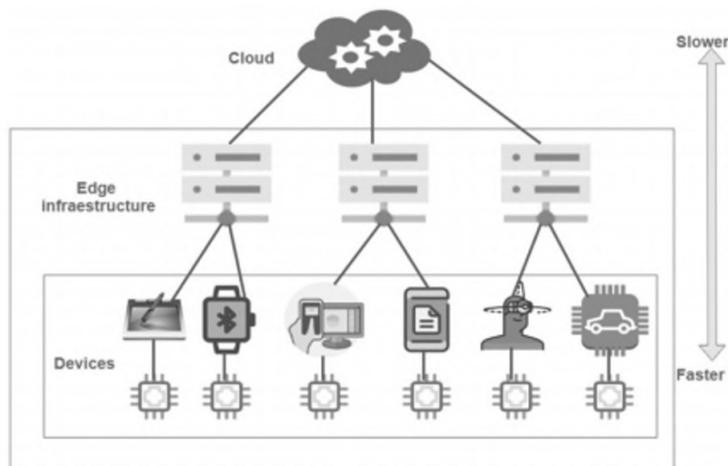

Figure 4: Edge and cloud computing [3].

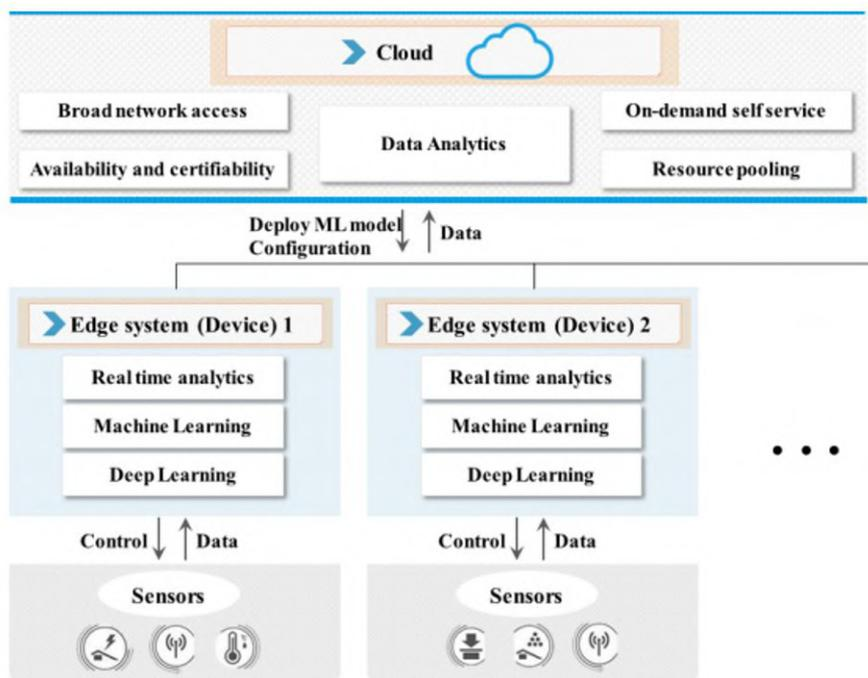

Figure 5: A design of edge computing environment supported by AI [8].

The registration of photoplethysmographic signals [24] is performed using the scheme shown in figure 7.

The analog part of the hardware consists of an optical sensor unit, an amplifier, and modulating equipment. The other units belong to the digital part. Amplified signals coming from the sensor

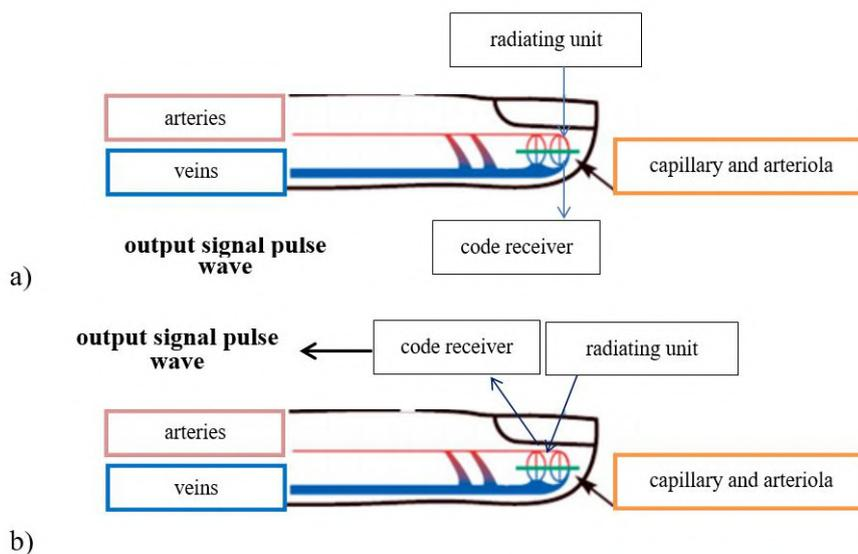

Figure 6: Ways of sensors location for blood circulation registration: a) on the lumen, b) on the reflection.

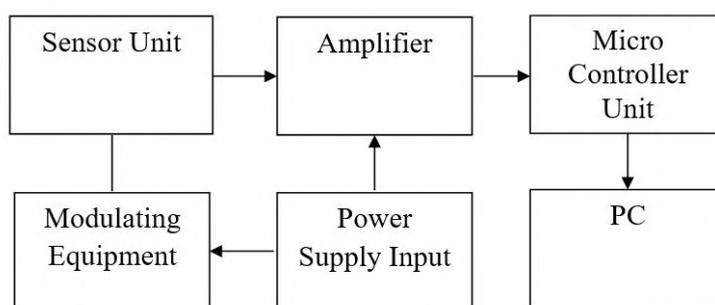

Figure 7: The survey plan of information system hardware.

unit, via USB-input are transmitted to the PC and the program window displays a pre-processed photoplethysmographic signal.

To transfer data from the microcontroller to the PC, USB port is used.

The method of photoplethysmography allows the use of non-contact sensors. Therefore, there is no artery compression, which eliminates circulatory disorders and allows the use of calculations to determine the saturation of oxygen by the pulse wave. Taking into consideration that the hardware of the signal recording system is required for further transmission, processing and analysis of pulse waves, the method of finger photoplethysmography is insufficient in its practical use.

On the one hand, the method is sufficient if the end phalanx of the finger or foot is X-rayed on one side by ordinary incoherent light, which after side-scattering enters the photodetector; however, on the other hand, this method is not appropriate to obtain sufficiently intense signals

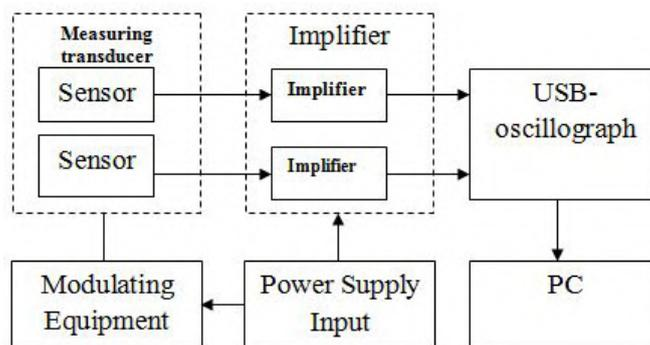

Figure 8: The survey plan of BTS pulsogram hardware based on the parameters of the photopulse oxygenation on the basis of PC.

from radial artery. However, it should be mentioned that the signal from radial artery is the most informative for cardiovascular system diagnosis. Nonetheless, this signal also depends on the human body constitution, its anthropometric parameters in particular. To consider this and to make the study of pulse waves and cardiovascular system more reliable we recommend controlling the intensity of infrared light depending on the human body constitution. The use of one optocoupler is not enough for this due to the low power of the light quantity and the depth of its penetration. It is recommended to use several optocouplers connected in series, parallel or parallel-series in a chain, with control of their mode of operation from the intensity of the received pulse wave signal depending on human body constitution (figure 8). Small optocouplers design allows doing it on a small plane, which the sensor itself has.

In the case of photopulse oxygenation, we are interested in the absorption of light quantity by blood running through veins, arterial blood in particular. Thus, the aim of pulse oximetry is to measure the level of saturation of hemoglobin in arterial blood with oxygen.

Hemoglobin is the common name for blood proteins found in red blood cells. Oxyhemoglobin is fully oxygenated hemoglobin, each molecule of which contains four oxygen molecules. Deoxyhemoglobin is hemoglobin that does not contain any oxygen.

The tissues through which both light quantity pass are a non-selective filter and evenly attenuate the radiation of both LEDs. The degree of attenuation depends on tissues thickness, skin pigment and other obstacles in the way of light. Hemoglobin, in contrast to tissues, is a color filter, and the color of this filter is affected by the level of oxygen saturation of hemoglobin. Deoxyhemoglobin has a dark cherry color. It intensively absorbs red light and weakly delays infrared. Therefore, if to put blood that does not contain any oxygen under the red and infrared light, the first one will be almost completely held, and the second one will be only slightly weakened. Conversely, oxyhemoglobin scatters red light (therefore, it has a red color), but intensively absorbs infrared radiation.

Thus, the ratio of two light quantities under the photodetector depends on blood oxygen saturation level. According to these data, using a certain algorithm, the microprocessor calculates the percentage of oxyhemoglobin in the blood.

Therefore, using the unit of photoplethysmography and implying the methods of photoplethysmographic signal digital processing, we obtain the result as shown in figure 9.

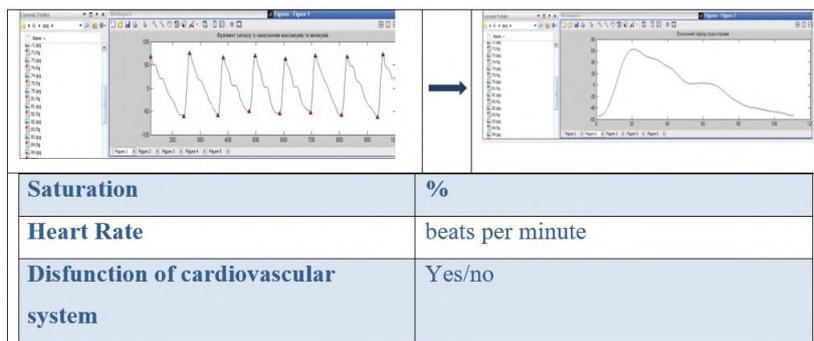

Figure 9: the program window.

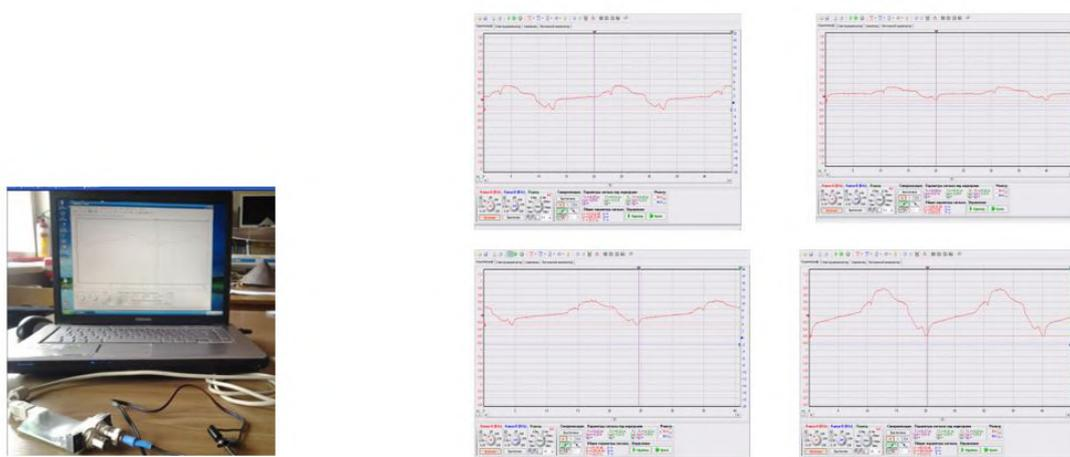

Figure 10: The hardware and software complex overview and the window with pulsegrams.

In order to read the pulse signal, it is possible to connect the sensor directly to the laptop, previously pre-amplifying the signal. Moreover, it is also possible to implement a small model in the MATLAB package [17, 23] for further analysis of pulsegrams. It should be noted that the display of the pulse graph is in real time. What is more, data can be stored in the database. It is rather convenient for keeping the records and dealing with statistics.

Non-invasive methods of registration, analysis and evaluation of amplitude-time parameters of pulse signals [2, 4, 16, 21, 25, 35] are viewed as a set of modern technical means and mathematical methods of processing biosignals. Nowadays, they define the current trends in cardiovascular system as well as other systems diagnostics. Furthermore, determination of additional values of saturation and body temperature is an important issue which is not restricted to rapid students' diagnostics only.

3. Conclusions

The paper proposes a device for recording pulse signals, which can record not only the heart rate but also measure saturation, which significantly minimizes the design of the device.

The edge device hardware is a part of the IoT system, which also includes another edge device, which instantly transmits data to the database on the edge server for the data further processing and storage. In addition, further detailed study of edge device data as a part of the IoT System is needed. Furthermore, the development of a mobile application to display the data is planned. This will allow you to monitor changes in the physiological parameters of the student in real-time around the clock and/or record on the server and, if necessary, view them.

References

- [1] Alekseev, V.A., Perminov, A.S. and Yuran, S.I., 2011. Mutual arrangement of the source and receiver of the sensor radiation for photoplethysmography. *Instruments and methods of measurements*, 1(2).
- [2] Ayusheeva, L.V., Boronoev, V.V., Lebedintseva, I.V. and Ledneva, I.P., 2009. Time parameters of the pulse wave in the diagnostics of human diseases according to the tradition of Tibetan medicine. *Biomedical Radioelectronics*, 3, pp.17–23.
- [3] Candanedo, I.S. and Corchado, J.M., 2019. An Edge Computing Tutorial. *Orient. J. Comp. Sci. and Technol.*, 12(2). Available from: <https://doi.org/10.13005/ojcs12.02.02>.
- [4] Fainzilberg, L.S., 2017. New opportunities of phasegraphy in medical practice. *Science and Innovation*, 13(3), pp.37–50.
- [5] Gorna, O., Stanishevskaya, T., Kopulova, T., Yusupova, O. and Horban, D., 2020. Research of the somatic health of student youth using information and communication technologies. *E3S Web of Conferences*, 166. Available from: <https://doi.org/10.1051/e3sconf/202016610034>.
- [6] Hanchuk, O., Bondarenko, O., Varfolomyeyeva, I., Pakhomova, O. and Lohvynenko, T., 2020. Couchsurfing as a virtual hospitality network and a type of sustainable youth tourism. *E3S Web of Conferences*, 166. Available from: <https://doi.org/10.1051/e3sconf/202016609005>.
- [7] Hassan, N., Gillani, S., Ahmed, E., Yaqoob, I. and Imran, M., 2018. The Role of Edge Computing in Internet of Things. *IEEE Communications Magazine*, 56(11), pp.110–115. Available from: <https://doi.org/10.1109/MCOM.2018.1700906>.
- [8] Huh, J. and Seo, Y., 2019. Understanding Edge Computing: Engineering Evolution With Artificial Intelligence. *IEEE Access*, 7, pp.164229–164245. Available from: <https://doi.org/10.1109/ACCESS.2019.2945338>.
- [9] Isupov, I.B. and Zatrudina, R.S., 2018. Electronic module for photoplethysmography and pulse oximetry. *Natural Systems and Resources*, 8(3).
- [10] Kachmar, V.O. and Avramenko, V.I., 2011. Directions of development of information technologies in medicine. *Medicine of transport of Ukraine*, 3, pp.96–103.
- [11] Kachmar, V.O. and Khvyshchun, A.I., 2008. Electronic medical record of the patient. Mutual compatibility and standardization. *Ukrainian Journal of Telemedicine and Medical Telematics*, 6(1), pp.76–79.
- [12] Kiv, A., Soloviev, V., Semerikov, S., Danylchuk, H., Kibalnyk, L. and Matviychuk, A.,

2019. Experimental economics and machine learning for prediction of emergent economy dynamics. *CEUR Workshop Proceedings*, 2422, pp.1–4.
- [13] Klochko, O., Fedorets, V., Maliar, O. and Hnatuyk, V., 2020. The use of digital models of hemodynamics for the development of the 21st century skills as a components of healthcare competence of the physical education teacher. *E3S Web of Conferences*, 166. Available from: <https://doi.org/10.1051/e3sconf/202016610033>.
- [14] Klochko, O.V., Fedorets, V.M., Uchitel, A.D. and Hnatyuk, V.V., 2020. Methodological aspects of using augmented reality for improvement of the health preserving competence of a Physical Education teacher. *CEUR Workshop Proceedings*, 2731, pp.108–128.
- [15] Kopnyak, K.V., 2017. Estimation of efficiency of medical information systems introduction. *Economy and organization of management*, 2(26), pp.109–119.
- [16] Kozlovskaya, T.I., 2012. *Optical-electronic device for diagnosing the state of peripheral circulation with high reliability*. Ph.D. thesis. Vinnytsia National Technical University, Vinnytsia.
- [17] Leonenkov, A.V., 2005. *Fuzzy modeling in MATLAB and fussy TECH*. BHV-Petersburg.
- [18] Lorido-Botran, T. and Bhatti, M.K., 2021. ImpalaE: Towards an optimal policy for efficient resource management at the edge. *CEUR Workshop Proceedings*, 2850, pp.71–82. Available from: <http://ceur-ws.org/Vol-2850/paper5.pdf>.
- [19] Lutsenko, I., Vihrova, E., Fomovskaya, E. and Serdiuk, O., 2016. Development of the method for testing of efficiency criterion of models of simple target operations. *Eastern-European Journal of Enterprise Technologies*, 2(4), pp.42–50. Available from: <https://doi.org/10.15587/1729-4061.2016.66307>.
- [20] Meshko, H., Meshko, O., Drobyk, N. and Mikheienko, O., 2020. Psycho-pedagogical training as a mean of forming the occupational stress resistance of future teachers. *E3S Web of Conferences*, 166. Available from: <https://doi.org/10.1051/e3sconf/202016610023>.
- [21] Mosiychuk, V.S., 2011. *Multisignal digital registration and processing of pulse wave parameters*. Ph.D. thesis. Nat. tech. University of Ukraine 'Kyiv Polytechnic Institute', Kyiv.
- [22] Munir, S., Guilcher, A., Kamalesh, T., Clapp, B., Redwood, S., Marber, M. and Chowienczyk, P., 2008. Peripheral Augmentation Index Defines the Relationship Between Central and Peripheral Pulse Pressure. *Hypertension*, 51(1), pp.112–118. Available from: <https://doi.org/10.1161/HYPERTENSIONAHA.107.096016>.
- [23] Nikitchuk, T.M., 2015. Devising an information system for the analysis of pulse signals. *Eastern-European Journal of Enterprise Technologies*, 5(9(77)), p.19–23. Available from: <https://doi.org/10.15587/1729-4061.2015.51219>.
- [24] Nikitchuk, T.N., Manoilov, V.F. and Martynchuk, P.P., 2012. Recording technique of photoplethysmographic signals for study in the phase plane. *2012 22nd International Crimean Conference "Microwave Telecommunication Technology"*. pp.981–982.
- [25] Nikitchuk, T.N. and Manoylov, V.F., 2011. The technique of pulse signals processing in a phase plane. *2011 21st International Crimean Conference "Microwave Telecommunication Technology"*. pp.1040–1041.
- [26] Nosenko, Y. and Sukhikh, A., 2019. The method for forming the health-saving component of basic school students' digital competence. *CEUR Workshop Proceedings*, 2393, pp.178–190.
- [27] Nosenko, Y., Sukhikh, A. and Dmytriienko, O., 2020. Organizational and pedagogical

- conditions of ICT health-saving usage at school: Guidelines for teachers. *CEUR Workshop Proceedings*, 2732, pp.1069–1081.
- [28] Pavlov, S.V., Kozhemyako, V.P., Petruk, V.G. and Kolisnyk, P.F., 2007. *Photoplethysmographic technologies of control of the cardiovascular system*. Vinnytsia: UNIVERSUM-Vinnytsia.
- [29] Rogatkin, D.A., 2012. Physical basis of optical oximetry. *Medical Physic*, 2, pp.97–114.
- [30] Ryabko, A.V., Zaika, O.V., Kukharchuk, R.P. and Vakaliuk, T.A., 2021. Graph model of Fog Computing system. *CEUR Workshop Proceedings*, 2850, pp.28–44. Available from: <http://ceur-ws.org/Vol-2850/paper2.pdf>.
- [31] Semerikov, S., Chukharev, S., Sakhno, S., Striuk, A., Osadchyi, V., Solovieva, V., Vakaliuk, T., Nechypurenko, P., Bondarenko, O. and Danylchuk, H., 2020. Our sustainable coronavirus future. *E3S Web of Conferences*, 166, p.00001. Available from: <https://doi.org/10.1051/e3sconf/202016600001>.
- [32] Shiyani, D., Ostapchuk, I. and Lakomova, O., 2020. Geographical analysis of ecology-dependent diseases of Kryvyi Rih population in order to provide a sustainable development of the industrial regions. *E3s web of conferences*, 166. Available from: <https://doi.org/10.1051/e3sconf/202016601012>.
- [33] Shurygin, I.A., 2000. *Respiration monitoring: pulse oximetry, capnography, oximetry*. Moscow: BINOM.
- [34] Soloviev, V.N. and Belinskiy, A., 2019. Complex Systems Theory and Crashes of Cryptocurrency Market. *Communications in Computer and Information Science*, 1007, pp.276–297. Available from: https://doi.org/10.1007/978-3-030-13929-2_14.
- [35] Voloshin, O.A., Oleinik, V.P., Kulish, S.N. and Sami, A.O., 2010. ECG method for diagnostics of human functional state on the basis of fractal analysis and wavelet transform. *Radioelectronics and Computer systems*, 4(45), pp.29–34.
- [36] Zelinska, S.O., Azaryan, A.A. and Azaryan, V.A., 2018. Investigation of opportunities of the practical application of the augmented reality technologies in the information and educative environment for mining engineers training in the higher education establishment. *CEUR Workshop Proceedings*, 2257, pp.204–214.