

UDC 504.052

DOI: 10.5281/zenodo.1313470

**Murad A. A. Almekhlafi**, PhD, Associate Professor  
Sana'a University, Sana'a, Yemen

## JUSTIFICATION OF THE ADVISABILITY OF USING SOLAR ENERGY FOR THE EXAMPLE OF THE YEMEN REPUBLIC

The objective of this work is to study and analyze deeply the evaluation of the state of the energy sector in Yemen and to justify the use of solar energy through statistical results with a scientific, ecological, economic and financial perspective. In the article shows in Yemen a strong dependence on traditional energy, which is dependent on fossil fuels, petroleum, and its derivatives, is one of the main causes that cause severe damage to human beings, the environment, and all living organisms. Electricity in Yemen, mainly depends on oil power plants – 699 MW of diesel, 495 MW of steam, and 341 MW from gas power plants. The total capacity of the national grid in 2013 was 1,535 MW. The power plants generate electrical power at different voltage levels, which are 10.5 KV, 11 KV, 13.8 KV, and 15 KV and then the voltage levels are boosted to the transmission voltage levels of 230 KV and 400 KV. Determined that when the industrial plants are isolated from the grid, they consume a large amount of diesel to generate electricity. Such consumption is 79,000 tons of diesel per year to generate approximately 127 MW. The further work of the power sector on diesel fuel is a growing problem both for the country's economy and for the ecology of the environment. The only solution and the alternative source of electricity and economy in the country is the use of renewable energy of all kinds and according to priorities. But the use of geothermal water is environmentally hazardous. Because of the lack of water in the Yemen Republic, that can lead to droughts and required a large consumption of diesel fuel for pumping of groundwater. The results show that Yemen is considered one of the richest countries in the world with regards to solar radiation. It is necessary to strengthen cooperation with researchers from the academic institutions and institutions concerned in study and in the creation of energy sources based on solar energy.

**Keywords:** environmental safety; clean energy; solar radiation; electricity.

### 1. Problem statement.

The use of excessive conventional energy, which is dependent on fossil fuels, petroleum, and its derivatives, is one of the main causes that cause severe damage to human beings, the environment, and all living organisms [1, 2], resulting in unprecedented environmental pollution, global warming, global warming and acid rain. Of environmental disasters that in turn harm human health [3–5]. Attention to the environment is one of the most important points of measures to assess the civilization of countries and progress. Attention to the environment is one of the most important points of measures to assess the civilization of countries and progress. Which led to a challenge to create a balance between sustainable development and conservation of environmental data. And as the dependence on traditional energies occupy the bulk of the energy uses and their implications, whether due to depletion or the resulting pollutants on human health.

To ensure the rational use of natural resources and the preservation of clean ecology, the world is moving to the search for alternative renewable energies [6].

Renewable energy is characterized by several advantages, including direct and indirect. It aims to protect human health and preserve the natural environment. It also works to improve the living standards of the human being and reduce the poverty rate by finding ways to secure new employment opportunities and reduce harmful gas and thermal emissions and etc. Since thermal emissions are the cause acid rains that harms all agricultural crops and different forms of life. Renewable energy reduces the risk of acid rain, since the energy sources do not

contain combustion products and reduce the accumulation of harmful waste of various kinds and forms.

Therefore, the search alternative renewable energies that are clean and sustainable and serve the health of man and the environment is a very urgent problem for the whole world. Consider the possibility of solving this problem by example Yemen Republic.

Yemen is situated between 13N–16N latitude and 43.2–53.2 longitude at the south west of Asia. Yemen is surrounded by the Red Sea from the west and by Arab Sea and the Indian Ocean, Yemen's population is 527,970 km<sup>2</sup>, Yemen's population is 26,687,000 million in 2016, rising with the rise in the unemployment rate and the war against Yemen in the last three years and to the present day. At the same time, the economic weakness of the country, which is one of the main challenges in Yemen, Leading to widespread poverty and in rural areas, which account for 75 % of the total population.

Yemen is one of the least developed countries with a Gross domestic product (GDP) per capita of US \$ 1,086 per year. Human development is originally weak in illiteracy and lacks basic social services such as education, health, and energy [7, 8].

### 2. Analysis of the recent researches and publications opportunities for use of renewable energy in Yemen

Renewable Energy (RE) in Yemen has high potentials of renewable energy sources, namely: solar, wind and geothermal.

**Solar Energy.** The average solar radiation in Yemen is 450...550 Cal/cm<sup>2</sup>/day [7]. Figure 1 and 2 [9] shows

that Yemen is a country with high levels of solar radiation.

Yemen is geographically located in the region of the solar belt in the world, and the temperature is very high, and in particular between the coastal and desert areas, which constitute the majority of space in the

Republic of Yemen. The solar radiation ranges between 6.8...5.2 kWh/m<sup>2</sup>/day, and the average annual sunshine is between 7.3 and 9.1 hours/day, even in winter, and the average daily average of solar clocks is about 8...16 hours per day [7].

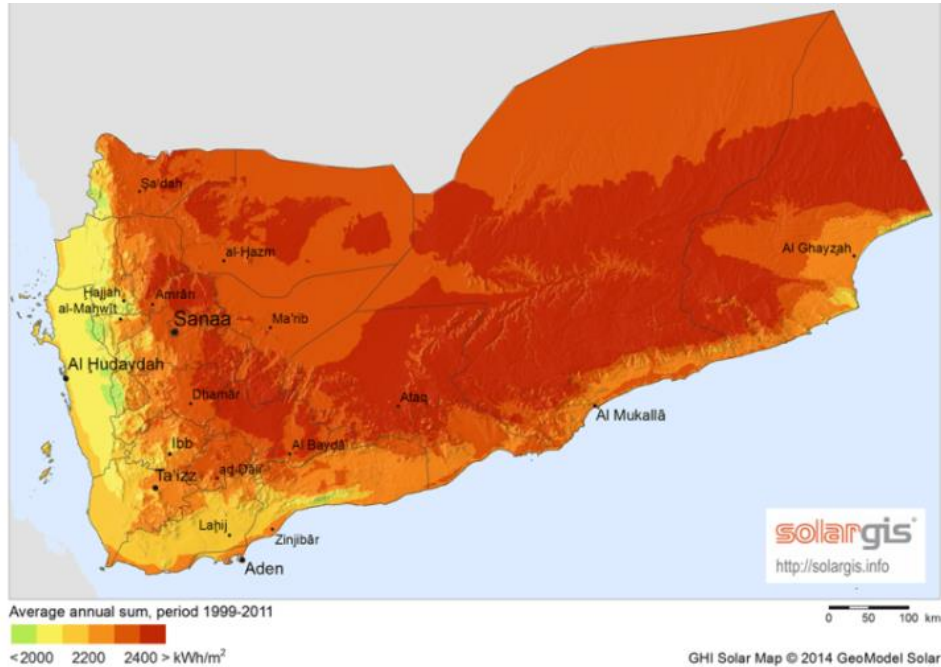

Figure 1 – Global horizontal irradiation (GHI) in Yemen Republic

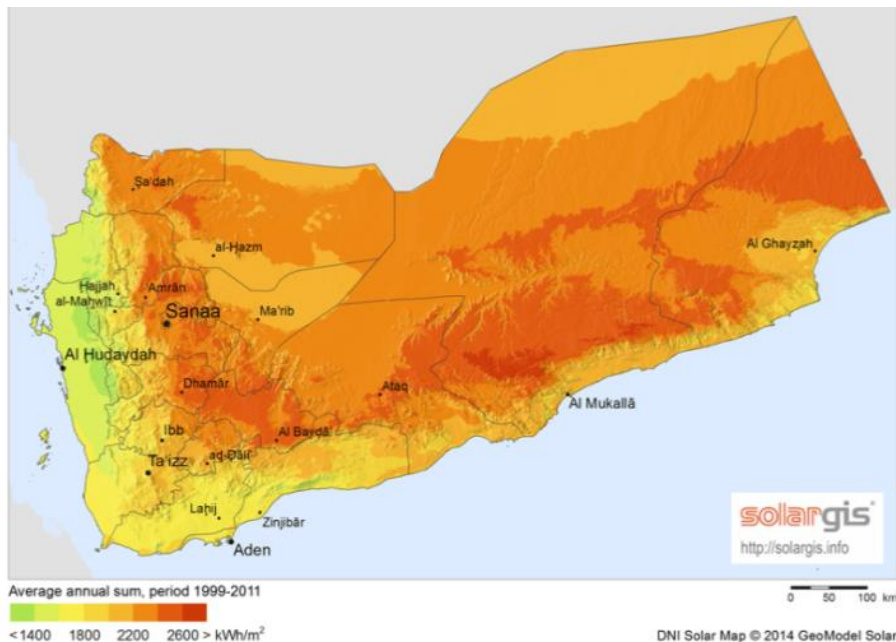

Figure 2 – Direct normal irradiation (DNI) in Yemen Republic

**Wind energy.** Yemen is considered one of the countries with coastal areas. It has a coastal area with a width of 2500 km and a width of thirty to sixty kilometers. It also owns several islands, most notably

Socotra, and there are marine areas and the most famous in terms of wind power such as the Mukha. Figure 3 [10] shows the wind resource maps of the Republic of Yemen.

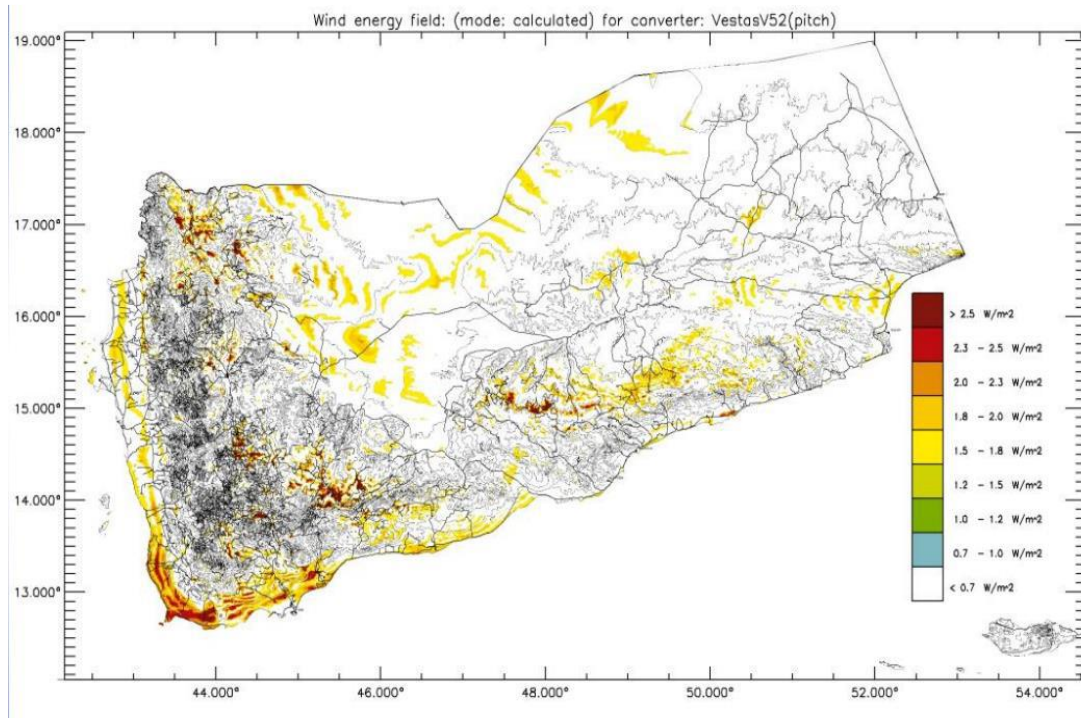

Figure 3 – Wind resource maps of the Yemen Republic

**Geothermal Energy.** It is also known internationally that Yemen is characterized by its nature by volcanic nature, and it has more than seven springs of natural hot water in several areas. It is possible to note from the global heat flow map that Italy and Yemen have the same heat flow, which is

60 MW/cm<sup>2</sup>, and the total combined geothermal energy in Italy is more than 500 MW. Yemen considers it to be a country with a high thermal flow and high thermal energy [11]. Figure 4 shows the Promising geothermal fields in Yemen [9].

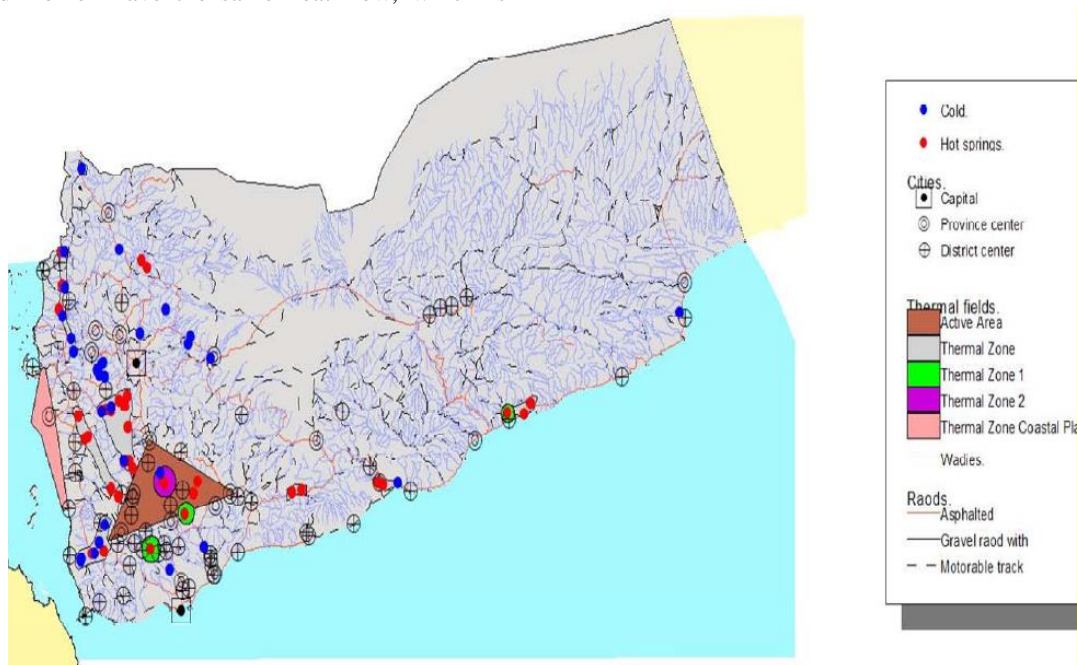

Figure 4 – Promising geothermal fields in Yemen

The Renewable energy capabilities in Yemen in table 1 [7] and the Weaknesses and Strengths of Renewable energy in Yemen in table 2 [10]. In 2009, Government of Yemen approved the national strategy

for RE and energy efficiency, which aims to increase 15 % of EE in the power sector by 2025 [10]. Targeted capacity of RE in total electricity (in MW) by 2025 is shown in figure 5.

Table 1 – Renewable Energy Capabilities In Yemen

Resource	Theoretical Potential (MW)	Technical Potential	
		Practicable (MW)	Gross (MW)
Solar Electric	2,446,000	1,426,000	18,600
Wind	308,722	123,429	34,286
Geothermal	304,000	29,000	2,900
Biomass (Landfill Gas)	10	8	6
Existing Dams	1	-	-
Major Wadis	12...31	11...30	-
Domestic (SWH)	3,014 MW thermal	278 MW thermal	278 MW thermal

Table 2 – Weaknesses and Strengths for Renewable energy in Yemen

Resource	Strengths	Weaknesses
Solar Electric	Renewable resource	Depending on sunshine levels
	A clean source of energy	High capital costs
	Long lifetime	Requires storage system
Wind	Renewable resource	Renewable resource
	A clean source of energy	Not reliable
	Sufficient level of maturity	Causes visual impact, noise, and electromagnetic interference
	Competitive in cost	Ecological impact Geothermal
Geothermal	Stable	Requires complex management system
	A clean source of energy	Not sustainable
Biomass/Biofuels	Available and free resource	Not sustainable
	Availability of conversion technologies	Competing land use

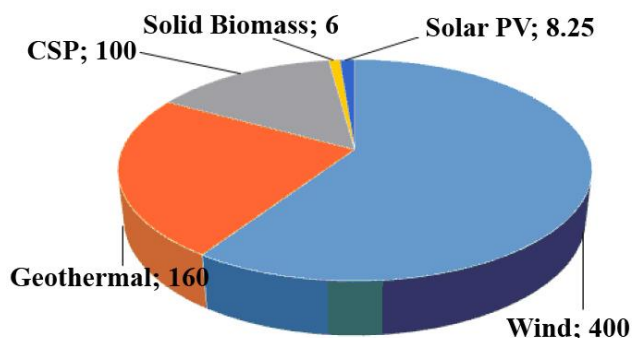

Figure 5 – Targeted capacity of RE in total electricity (in MW) by 2025

The objective of this work is to study and analyze deeply the evaluation of the state of the energy sector in Yemen and to justify the use of solar energy through statistical results with a scientific, ecological, economic and financial perspective.

**3. Statement of the problem and its solution.**

**3.1. Energy and Power System in Yemen**

The Ministry of Electricity and Energy serves the electricity sector in the Republic of Yemen by 80 % in the country [12], as shown in figure 6.

Figure 7 shows the share of total primary energy supply in 2012 [13, 14].

The Yemeni energy sector consists of oil, natural gas, and biofuels. Energy production in 2012 was «15,109 kiloton of oil equivalent (ktoe) while the consumption was 6,923 ktoe» [13]. In 2013, Yemen

generated «5,600 GWh of electricity 2,8 GWh from oil (steam and diesel power plants and 2,722 GWh of gas, and consumed 4,976 GWh)» [15].

Electricity in Yemen, mainly depends on oil power plants; «699 MW of diesel, 495 MW of steam, and 341 MW from gas power plants. The total capacity of the national grid in 2013 was 1,535 MW» [3]. The power plants generate electrical power at different voltage levels, which are «10.5 KV, 11 KV, 13.8 KV, and 15 KV and then the voltage levels are boosted to the transmission voltage levels of 230 KV and 400 KV» [3] and transmit energy by single line diagram of transmission network (figure 8).

The Figure 9 [16] above indicates a narrowing gap between the government’s share and total crude oil production with the passage of time.

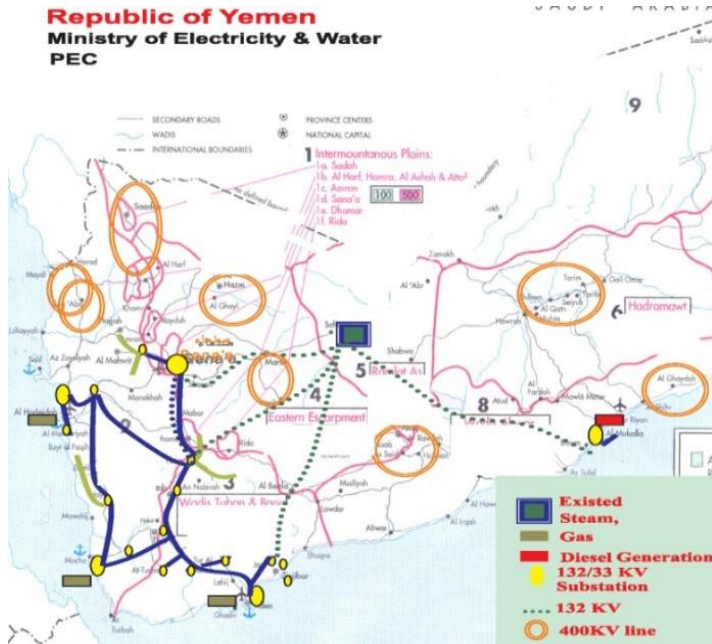

Figure 6 – The public electricity company (PEC)

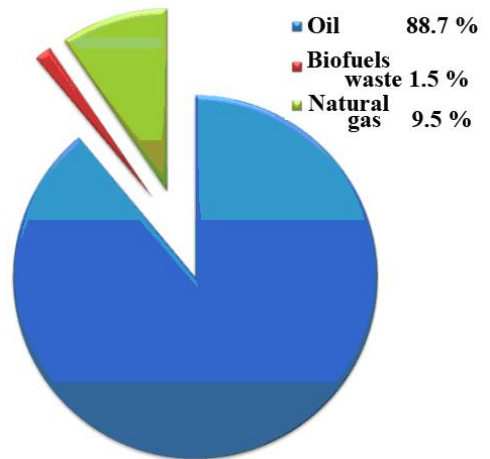

Figure 7 – Share of total primary energy supply in 2012

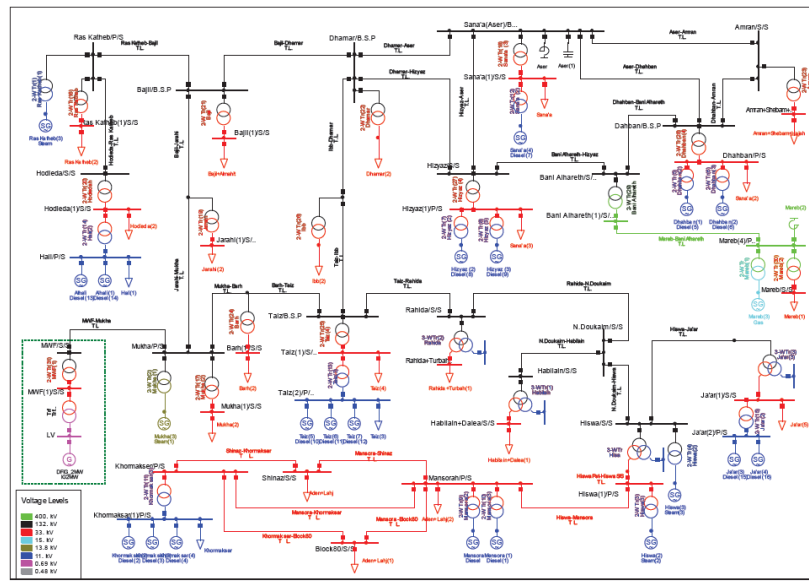

Figure 8 – Single line diagram of transmission network.

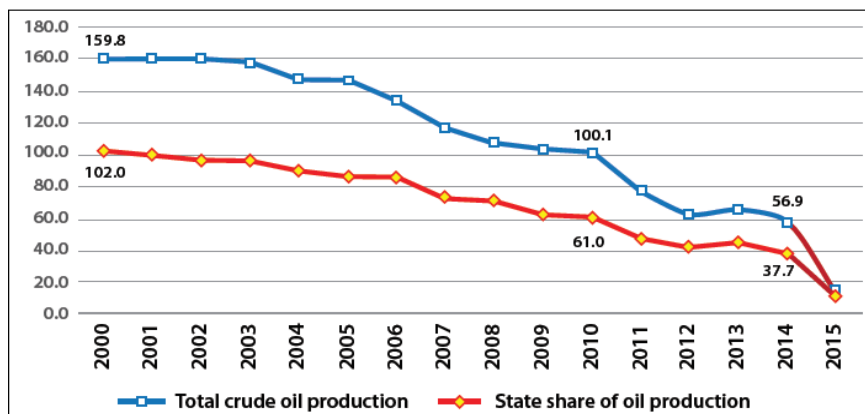

Figure 9 – Total crude oil production and state share (million barrels)

Electricity is the lowest in the region, with 40 % of the population connected to electricity. There is also inequality between rural and urban areas, 23 % have access to electricity in rural areas and 85 % in urban areas, although rural areas occupy 75 % of the population. Therefore, most rural areas receive electricity from other sources, including diesel generators. In addition to the fact that it is expensive (figure 10), the use of diesel generators pollutes the environment [17].

This means that the share of the government has increased (amounted to 70 % of the total production in 2013) while the share of origin companies has decreased.

The oil and gas production constituted nearly 24 % of Gross Domestic Product (GDP) of the oil and gas

sector at current prices during 2010–2014, despite the growing number of sabotage attacks on oil and gas infrastructure during the transitional period (figure 11) [14].

The report of the Ministry of Planning and International Cooperation Sector Economic Studies and Forecasting on 14 May 2016 [16], stated that The oil and gas revenues are the main resource of the state budget and contributed about 53.6 % of the total public revenues during 2010 – 2014. The oil and gas revenues have fallen by about 77.1 % in 2015 due to the war and conflict implications, as well as the lower world oil prices. The least amount exceeds the total public budget expenses on education, health and social protection. The following table 3 Government power plants in Yemen [18].

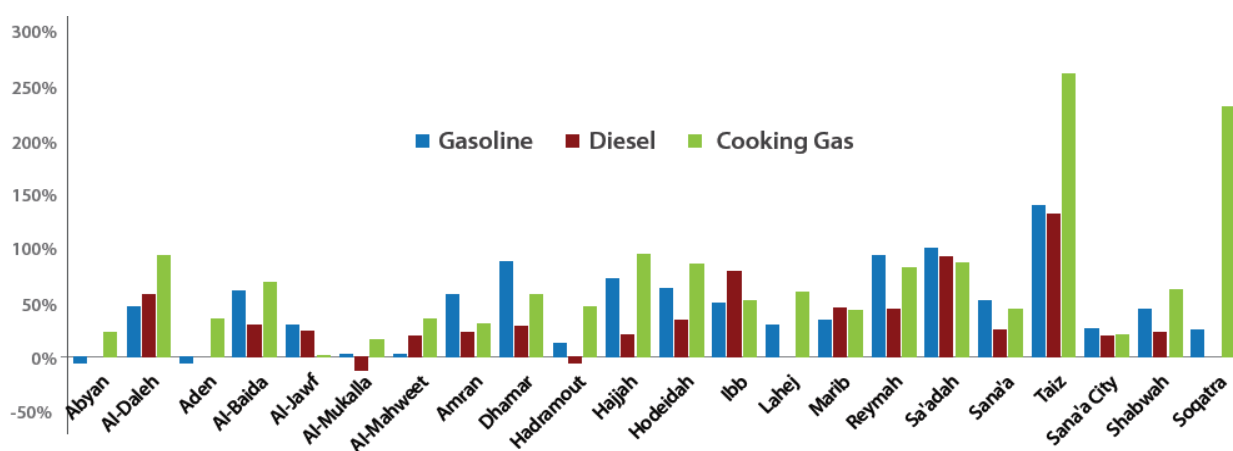

Figure 10 – Change of fuel prices on March 2016 compared to the pre - crisis period

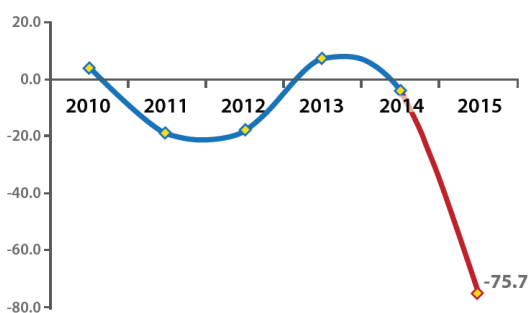

Figure 11 – Real GDP growth of oil and gas sector, %

Table 3 – Government power plants

City	Average Load (MW)	Annual energy production (MWh)
Al- Rayyan	3.8 <sup>14</sup>	28,296 <sup>15</sup>
Al-Hodeida	1.69	5.332
Shabwa	2.93	17.843
Socotra	1.18	5.863
Haja	2.48	6.068
Sa'da	2.09	34.778
Al-Monawwara	4.22	28,296 <sup>15</sup>
Al-Shehr	1.24	8.012
Al-Bayda	1.22	4.316
Khalaf	2.48	6.010
Al-Mahra	3.36	14.882

The main problem is that the Ministry of Electricity and Energy rents power stations from the private sector to close the gap between supply and demand so that the leased stations provide electricity Either on-line or off-grid, and the Government provides these stations with

diesel fuel (figure 12).

The following table 4 shows Estimates of Depreciation of Leased Stations for the Private Sector Offshore in Yemen (General Electricity Corporation 2014).

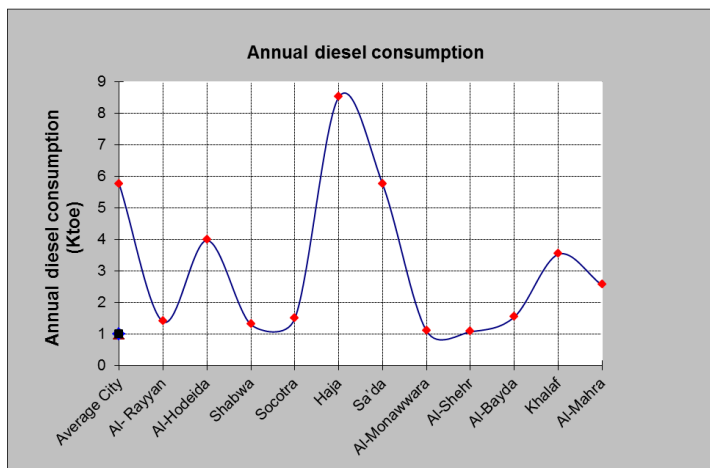

Figure 12 – Annual diesel consumption of Yemeni cities

Table 4 – Private sector power stations (chartered in Yemen)

Governorate	Purchased energy (MWh)
Al-Wadi	31.264
Al-Bayda	28.849
Coast of Hadhramaut	224.551
Al-Mahra	62.776
Lahj	19.910
Mareb	235.132
Shabwa	114.229

### 3.2. Private industrial facilities

In many cases, the Yemeni national network is subject to several interruptions of electricity and the interruptions are increasing from year to year. So the industrial plants are isolated from the grid and in nature they consume a large amount of diesel to generate electricity at the site. It is estimated that it consumes 79,000 tons of diesel per year to generate approximately 127 MW.

Another sector, the telecoms sector, has the largest diesel generators and unfortunately we cannot get data on diesel consumption.

### 3.3. Groundwater

Yemen is one of the most water-scarce countries in the world, with renewable water resources of only 125 m<sup>3</sup> per capita/year (i.e. Less than one tenth of the threshold for water stress, which is defined at 1,700 m<sup>3</sup> per capita/year). Demand for water is increasing year by year. Groundwater accounts for about 75 % of Yemen's total water consumption. The agricultural sector accounts for almost 90 % of total consumption, while the industrial and domestic sectors account for approximately 9 % of water resources.

The cultivated area of Yemen irrigated by groundwater is estimated 405,264 hectares. Of the total area of groundwater irrigation, Highlands accounts for the largest share, with about 69 % of the total, followed by Coastal Area with 18 % and Eastern Plate with 13 %. Thus, groundwater resources are vital for Yemen's agriculture. In table 5 shows diesel consumption for groundwater pumping (Ministry of Industry and Trade – Yemen, 2015) [18]:

Table 5 – Diesel consumption of groundwater pumping

Area	Annual ground-water with drawal (Billion m <sup>3</sup> )	Specific diesel consumption (liters/m <sup>3</sup> )	Annual diesel consumption (ktoe)
Coastal areas	1.4	0.43	514.7
Highlands	1.6	0.75	1.026
Eastern Plateau	0.6	0.21	107.73
Total	3.6	1.39	623.456

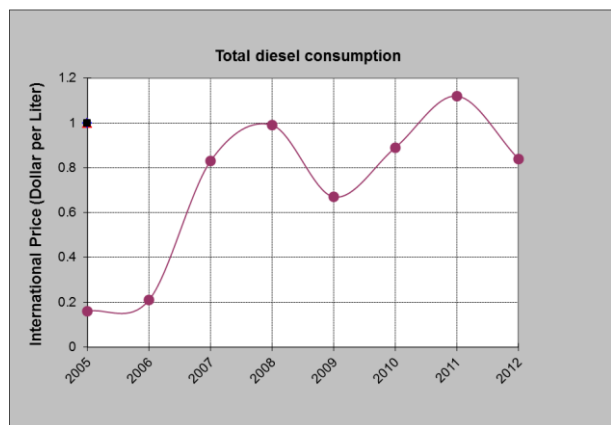

Figure 13 – Total diesel consumption from 2005 to 2012

For irrigation by groundwater, farmers rely on diesel-based pumps to draw water from the aquifers through wells. The average temperature increase in Yemen is increasing when compared to the global average, and it is known that most of the area of Yemen consists of arid semi-arid regions. This makes things worse, although the rate of rainfall under climate change cannot be relied upon because it is uncertain.

### 4. Results and Discussion.

According to the results of the study, reports, and statistics presented in this study from 2000 to 2016, the government's dependence on diesel to operate the electricity sector is a major factor for the deterioration of the ecological safety and economy in the country with the same price decline of 77 % between the years 2009 and 2017. The further work of the power sector on diesel fuel is a growing problem both for the country's economy and for the ecology of the environment.

The only solution and the alternative source of electricity and economy in the country is the use of renewable energy of all kinds and according to priorities. Important is that Yemen has very good potential for using renewable energy. This is evident from figures 1–4. But the use of geothermal water is environmentally hazardous. Firstly, because of the lack of water in the Yemen Republic. This can lead to droughts and other negative consequences for the environment at the same time threatens the country's economy. Secondly, required a large consumption of diesel fuel for pumping of groundwater. This is evident from table 5.

The most rational and promising direction in the energy sector is the use of solar energy.

Currently, the entire scientific world is actively developing the direction to create environmentally safe and effective materials for the creation of solar cells [19, 20]. Therefore, it is necessary to strengthen cooperation with researchers from the academic institutions and institutions concerned in study and in the creation of energy sources based on solar energy.

In the end, we must go back to the famous parable, «the sun is a God gift, so let's use it».

### Conclusion.

In this article, we provided a brief overview of the Yemeni file, which included the electric power sector and the environmental and economic situation (oil, diesel and gas) and the possibility of applying

renewable energy in different types according to the location and resources of Yemen Republic.

The main findings of the study can be summarized as follows:

1. The further work of the power sector on diesel fuel is a growing problem both for the country's economy and for the ecology of the environment. When the industrial plants are isolated from the grid and in nature they consume a large amount of diesel to generate electricity at the site. It is estimated that it consumes 79,000 tons of diesel per year to generate approximately 127 MW. The only solution and the alternative source of electricity and economy in the country is the use of renewable energy of all kinds and according to priorities.

2. Yemen has very good potential for using renewable energy. Namely, solar energy, wind energy and Geothermal Energy.

3. But the use of geothermal water is environmentally hazardous. Firstly, because of the lack of water in the Yemen Republic. This can lead to droughts and other negative consequences for the environment at the same time threatens the country's economy. Secondly, required a large consumption of diesel fuel for pumping of groundwater. This is evident from table 5.

4. The most rational and promising direction in the energy sector is the use of solar energy.

Therefore, it is necessary to strengthen cooperation with researchers from the academic institutions and institutions concerned in study and in the creation of energy sources based on solar energy.

### REFERENCES

- Balaceanu, C. M., Iordache, G. (2018). Assessment of the air pollution at the industrial stations in metropolitan area of Bucharest. *Naukovo-tekhnichnyy Zhurnal «Tekhnogenno-ekologichna bezpeka»*, 3(1/2018), 8–15. doi: 10.5281/zenodo.1182485.
- Vambol, S., Kondratenko, O. (2017). Results of complex criterial fuel and ecological assessment of diesel engine 2Ch10.5/12 for emergency and rescue power plants. *Naukovo-tekhnichnyy Zhurnal «Tekhnogenno-ekologichna bezpeka»*, 1, 32–38. doi: 10.5281/zenodo.1182876.
- Murad A. A. Almekhlafi, Shafea M. Al-yousofi, Mohammed M. Alkhawani. (2015). Performance analysis of BFSK multi-hop communication systems over k-fading channel using generalized gaussian finite-mixture technique. *International Journal of Wireless & Mobile Networks (IJWMN)*, 7(6).
- Murad A. A. Almekhlafi. (2017). Analytical study for measuring the electromagnetic radiation of the GSM system in urban areas. *International Journal of Computer Networks & Communications (IJCNC)*, 9(1).
- Sobol', O. M., Maksimov, A. V. (2017). Postanovka zadachi vyznachennya optymal'noyi kil'kosti ta mist' roztashuvannya teploelektrostantsiy na tverdykh pobutovykh vidkhodakh. *Naukovo-tekhnichnyy Zhurnal «Tekhnogenno-ekologichna bezpeka»*, 1, 56–60.
- Bogdanov, I., Vambol, V., Suchikova, Y. (2017). The improvement environmental safety of nanomaterials by means of environmental assessment. *Naukovo-tekhnichnyy Zhurnal «Tekhnogenno-ekologichna bezpeka»*, 2, 44–49. doi: 10.5281/zenodo.1182880.
- Prospects of Solar Energy in Yemen: A Policy paper (UNDP Yemen January 2014).
- Murad A. A. Almekhlafi. (2016). Analytical study to assess the performance and quality GPRS network for some of the cells in Sana'a. *International Journal of Computer Networks and Communications Security*, 4(11), 309–315.
- Maged M. Al-Barashi, Doaa K. Ibrahim, Essam El-Din Abo El-Zahab. (2016). Evaluating the energy system in Yemen. *Journal of Electrical Engineering*, 16(1), 338–342.
- Guide to Renewable Energy and Energy Efficiency in the Arab States, League of Arab States, 2013.
- Ali M. AL-Ashwal. (2005). All Renewable energy applications in Yemen are best practice. *ISECO Science and Technology Vision*, 1, 45–50.
- The Public Electricity Company PEC High Voltage System (400/132/33/11KV), PEC, Yemen, 2011.
- Renewables Interactive Map – Country Profile: Yemen. Available: [http://www.map.ren21.net/Yemen\\_Renewables\\_Profile](http://www.map.ren21.net/Yemen_Renewables_Profile), REN21. – Generated on: 05/16/2015.
- International Energy Agency. Statistics on the web: <http://www.iea.org/statistics/>. Generated on: 05/16/2015.



15. Statistical Bulletin (2013). Arab Union of Electricity, Issue 22. Reflection, J. Phys. Soc. Jpn. 75 (2006) 084801.
16. Ministry of Planning & International Cooperation. Economic Studies & For casting Sector (2016).
17. Vambol, S., Kondratenko, O. (2017). Calculated substantiation of choice of units of monetary equivalents of complex fuel and ecological criteria components. *Naukovo-tekhnichnyy Zhurnal «Tekhnogenno-ekolohichna bezpeka»*, 2, 53–60. doi: 10.5281/zenodo.1182890.
18. Ministry of Industry and Trade – Yemen, 2015.
19. Bohdanov, I. T., Sychikova, Ya. O., Vambol, S. O., Vambol, V. V. (2018). Zabezpechennya ekolohichnoyi bezpeky nanomaterialiv cherez upravlinnya yakistyu nanostruktur. *Naukovo-tekhnichnyy Zhurnal «Tekhnogenno-ekolohichna bezpeka»*, 3(1/2018), 21–27. doi: 10.5281/zenodo.1182493.
20. Naddaf, M., Saad, M. (2013). Novel optical and structural properties of porous GaAs formed by anodic etching of n+-GaAs in a HF:C<sub>2</sub>H<sub>5</sub>OH:HCl:H<sub>2</sub>O<sub>2</sub>:H<sub>2</sub>O electrolyte: effect of etching time. *Journal of Materials Science: Materials in Electronics*, 24(7), 2254–2263. doi: 10.1007/s10854-013-1087-4.

Received: 26 June 2018

Accepted: 17 July 2018

**Мурад А. А. Алмехлафі**

### **ОБҐРУНТУВАННЯ ДОЦІЛЬНОСТІ ВИКОРИСТАННЯ СОНЯЧНОЇ ЕНЕРГІЇ НА ПРИКЛАДІ РЕСПУБЛІКИ ЙЕМЕН**

Мета цієї роботи – детально вивчити і проаналізувати оцінку стану енергетичного сектора в Ємені та обґрунтувати використання сонячної енергії за допомогою статистичних результатів з науковою, екологічною, економічною і фінансовою перспективою. У статті показано, що в Ємені існує сильна залежність від традиційної енергії, як викопне паливо, нафта та її похідні. Це є однією з основних причин, які завдають серйозної шкоди людям, навколишньому середовищу і всім живим організмам. Електрика в Ємені в основному залежить від нафтових електростанцій – 699 МВт дизельного палива, 495 МВт пара і 341 МВт від газових електростанцій. Загальна потужність національної мережі в 2013 році склала 1535 МВт. Електростанції генерують електроенергію при різних рівнях напруги, які становлять 10,5 кВ, 11 кВ, 13,8 кВ і 15 кВ, а потім рівні напруги підвищуються до рівнів напруги передачі 230 кВ і 400 кВ. Встановлено, що, коли промислові установки ізольовані від мережі, вони споживають велику кількість дизельного палива для вироблення електроенергії. Таке споживання становить 79000 тонн дизельного палива на рік для виробництва приблизно 127 МВт. Подальша робота енергетичного сектора на дизельному паливі є наростаючою проблемою як для економіки країни, так і для екології навколишнього середовища. Єдиним рішенням і альтернативним джерелом електроенергії в країні є використання відновлюваних джерел енергії всіх видів і відповідно до пріоритетів. Але використання геотермальної води є екологічно небезпечним. Через брак води в Єменській республіці, що може привести до засух і зажадати великого споживання дизельного палива для перекачування підземних вод. Результати показують, що Ємен вважається однією з найбагатших країн у світі щодо сонячної радіації. Необхідно зміцнювати співробітництво з дослідниками з академічних установ та установ, що займаються вивченням і створенням джерел енергії на основі сонячної енергії.

**Ключові слова:** екологічна безпека; чиста енергія; сонячна радіація; електрика.

### **ЛІТЕРАТУРА**

1. Balaceanu C. M., Iordache G. Assessment of the air pollution at the industrial stations in metropolitan area of Bucharest // *Техногенно-екологічна безпека*. 2018. Вип. 3(1/2018). С. 8–15. doi: 10.5281/zenodo.1182485.
2. Vambol S., Kondratenko O. Results of complex criterial fuel and ecological assessment of diesel engine 2Ch10.5/12 for emergency and rescue power plants // *Техногенно-екологічна безпека*. 2017. Вип. 1. С. 32–38. doi: 10.5281/zenodo.1182876.
3. Murad A. A. Almekhlafi, Shafea M. Al-yousofi, Mohammed M. Alkhawani. Performance analysis of BFSK multi-hop communication systems over k-fading channel using generalized gaussian finite-mixture technique // *International Journal of Wireless & Mobile Networks (IJWMN)*. 2015. Vol. 7, Issue 6.
4. Murad A. A. Almekhlafi. Analytical study for measuring the electromagnetic radiation of the GSM system in urban areas // *International Journal of Computer Networks & Communications (IJCNC)*. 2017. Vol. 9, Issue 1.
5. Соболев О. М., Максимов А. В. Постановка задачі визначення оптимальної кількості та місць розташування теплоелектростанцій на твердих побутових відходах // *Техногенно-екологічна безпека*. 2017. Вип. 1. С. 56–60.
6. Bogdanov I., Vambol V., Suchikova Y. The improvement environmental safety of nanomaterials by means of environmental assessment // *Техногенно-екологічна безпека*. 2017. Вип. 2. С. 44–49. doi: 10.5281/zenodo.1182880.
7. Prospects of Solar Energy in Yemen: A Policy paper (UNDP Yemen January 2014).
8. Murad A. A. Almekhlafi. Analytical study to assess the performance and quality GPRS network for some of the cells in Sana'a // *International Journal of Computer Networks and Communications Security*. 2016. Vol. 4, Issue 11. P. 309–315.

9. Maged M. Al-Barashi, Doaa K. Ibrahim, Essam El-Din Abo El-Zahab. Evaluating the energy system in Yemen // Journal of Electrical Engineering. 2016. Vol. 16, Issue 1. P. 338–342.
10. Guide to Renewable Energy and Energy Efficiency in the Arab States, League of Arab States, 2013.
11. Ali M. Al-Ashwal. All Renewable energy applications in Yemen are best practice // ISECO Science and Technology Vision. 2005. Vol. 1. P. 45–50.
12. The Public Electricity Company PEC High Voltage System (400/132/33/11KV), PEC, Yemen, 2011.
13. Renewables Interactive Map – Country Profile: Yemen. Available: [http://www.map.ren21.net/Yemen\\_Renewables\\_Profile](http://www.map.ren21.net/Yemen_Renewables_Profile), REN21. – Generated on: 05/16/2015.
14. International Energy Agency. Statistics on the web: <http://www.iea.org/statistics/>. Generated on: 05/16/2015.
15. Statistical Bulletin (2013). Arab Union of Electricity, Issue 22. Reflection, J. Phys. Soc. Jpn. 75 (2006) 084801.
16. Ministry of Planning & International Cooperation. Economic Studies & Forecasting Sector. 2016.
17. Vambol S., Kondratenko O. Calculated substantiation of choice of units of monetary equivalents of complex fuel and ecological criteria components // Техногенно-екологічна безпека. 2017. Вип. 2. С. 53–60. doi: 10.5281/zenodo.1182890.
18. Ministry of Industry and Trade – Yemen, 2015.
19. Богданов І. Т., Сичікова Я. О., Вамболь С. О., Вамболь В. В. Забезпечення екологічної безпеки наноматеріалів через управління якістю наноструктур // Техногенно-екологічна безпека. 2018. Вип. 3(1/2018). С. 21–27. doi: 10.5281/zenodo.1182493.
20. Naddaf M., Saad M. Novel optical and structural properties of porous GaAs formed by anodic etching of n+-GaAs in a HF:C<sub>2</sub>H<sub>5</sub>OH:HCl:H<sub>2</sub>O<sub>2</sub>:H<sub>2</sub>O electrolyte: effect of etching time // Journal of Materials Science: Materials in Electronics. 2013. Vol. 24, Issue 7. P. 2254–2263. doi: 10.1007/s10854-013-1087-4.

Надійшла: 26 червня 2018 р.

Прийнята: 17 липня 2018 р.

**Мурад А. А. Алмехлафи**

#### **ОБОСНОВАНИЕ ЦЕЛЕСООБРАЗНОСТИ ИСПОЛЬЗОВАНИЯ СОЛНЕЧНОЙ ЭНЕРГИИ НА ПРИМЕРЕ РЕСПУБЛИКИ ЙЕМЕН**

Цель этой работы – детально изучить и проанализировать оценку состояния энергетического сектора в Йемене и обосновать использование солнечной энергии посредством статистических результатов с научной, экологической, экономической и финансовой перспективой. В статье показано, что в Йемене сильная зависимость от традиционной энергии, как ископаемое топливо, нефть и ее производных. Это является одной из основных причин, которые наносят серьезный ущерб людям, окружающей среде и всем живым организмам. Электричество в Йемене в основном зависит от нефтяных электростанций – 699 МВт дизельного топлива, 495 МВт пара и 341 МВт от газовых электростанций. Общая мощность национальной сети в 2013 году составила 1535 МВт. Электростанции генерируют электроэнергию при разных уровнях напряжения, которые составляют 10,5 кВ, 11 кВ, 13,8 кВ и 15 кВ, а затем уровни напряжения повышаются до уровней напряжения передачи 230 кВ и 400 кВ. Установлено, что, когда промышленные установки изолированы от сети, они потребляют большое количество дизельного топлива для выработки электроэнергии. Такое потребление составляет 79000 тонн дизельного топлива в год для производства примерно 127 МВт. Дальнейшая работа энергетического сектора по дизельному топливу является нарастающей проблемой как для экономики страны, так и для экологии окружающей среды. Единственным решением и альтернативным источником электроэнергии в стране является использование возобновляемых источников энергии всех видов и в соответствии с приоритетами. Но использование геотермальной воды является экологически опасным. Из-за нехватки воды в Йеменской республике, которая может привести к засухам и потребовать большого потребления дизельного топлива для перекачки подземных вод. Результаты показывают, что Йемен считается одной из самых богатых стран в мире в отношении солнечной радиации. Необходимо укреплять сотрудничество с исследователями из академических учреждений и учреждений, занимающихся изучением и созданием источников энергии на основе солнечной энергии.

**Ключевые слова:** экологическая безопасность; чистая энергия; солнечная радиация; электричество.